

OUTDOOR

2025



NARDI

OUTDOOR

2025

DESIGN RAFFAELLO GALIOTTO



SCENOGRAFIE ALL'ARIA APERTA

NUOVE PROSPETTIVE DEL VIVERE ALL'ARIA APERTA. IMMERSI NEL VERDE DI GIARDINI E BALCONI, AL RIPARO DI PERGOLE E PORTICATI, AFFACCIATI SU PANORAMI DI TERRAZZE SUL MARE O AL COSPETTO DI Suntuose MONTAGNE. DOVE IL FASCINO DELL'OPEN AIR INCONTRA QUELLO DEGLI ELEMENTI D'ARREDO, GLI AMBIENTI ESTERNI PRENDONO VITA CON LE NOSTRE COMPOSIZIONI, DISEGNATE PER DEFINIRE GLI SPAZI ALL'APERTO ALL'INSEGNA DEL DESIGN E DI UN RICERCATO VENTAGLIO CROMATICO CHE SPOSA A TUTTOTONDO LE ESIGENZE DELL'OUTDOOR LIVING CONTEMPORANEO. ATMOSFERE SUGGERITIVE E RILASSANTI INCORNICIANO L'ELEGANZA DI CONFORTEVOLI COLLEZIONI DALLE LINEE PULITE E AVVOLGENTI, ERGONOMICHE E CONCEPITE SECONDO LA MASSIMA FUNZIONALITÀ A FAVORE DELLE PERSONE E DEL LORO SPAZIO VITALE. ISPIRATI ALLA BELLEZZA E ALLA PUREZZA DELLA NATURA, I NOSTRI PRODOTTI LA RIEVOCANO FIN NEI COLORI, E NE RIPRENDONO IL VALORE NELL'IMPRONTA PROFONDAMENTE GREEN. SONO INFATTI REALIZZATI IN MATERIALI RICICLABILI DI ALTA QUALITÀ, INTERAMENTE IN ITALIA, NONCHÉ PROGETTATI IN OTTICA DI ELEVATA RESISTENZA E DURABILITÀ NEL TEMPO.

OUTDOOR SETTINGS

NEW PERSPECTIVES OF OUTDOOR LIVING. SURROUNDED BY THE GREENERY OF GARDENS AND BALCONIES, SHELTERED BY PERGOLAS AND PORCHES, ON TERRACES OVERLOOKING THE SEA OR WITH MAJESTIC MOUNTAINS IN VIEW. WHERE THE APPEAL OF THE OPEN AIR ENCOUNTERS FURNITURE ELEMENTS, OUTDOOR ENVIRONMENTS COME TO LIFE WITH OUR COMPOSITIONS. THEY ARE DESIGNED TO CREATE OUTDOOR SPACES FEATURING STYLISH DESIGN AND A SOPHISTICATED RANGE OF COLOURS THAT PERFECTLY MEETS THE NEEDS OF CONTEMPORARY OUTDOOR LIVING. EVOCATIVE AND RELAXING ATMOSPHERES EMBRACE THE ELEGANCE OF COMFORTABLE COLLECTIONS WITH CLEAN, ENVELOPING AND ERGONOMIC LINES, DESIGNED WITH THE UTMOST FUNCTIONALITY FOR THE BENEFIT OF PEOPLE AND THEIR LIVING SPACES. INSPIRED BY THE BEAUTY AND PURITY OF NATURE, OUR PRODUCTS ALSO EVOKE NATURE IN THEIR COLOURS, REFLECTING ITS VALUE IN THEIR EXTREMELY GREEN FOOTPRINT. MADE OF HIGH-QUALITY RECYCLABLE MATERIALS, PRODUCED ENTIRELY IN ITALY, THEY ARE DESIGNED TO BE HIGHLY RESISTANT AND LONG-LASTING.

INDEX

10	MAXIMO MODULAR SYSTEM	74	SET RIO BENCH ALU	104	ATLANTICO
31	KOMODO MODULAR SYSTEM	78	NET COLLECTION	115	TECHNICAL DETAILS
46	TEVERE SYSTEM	93	DOGA COLLECTION		
63	RIO SYSTEM	100	FOLIO COLLECTION		





MAXIMO terra / cannella Sunbrella® _ MAXIMO TAVOLINO terra

Best of
NeoCon
2024

MAXIMO MODULAR SYSTEM

LINEE PULITE E DIMENSIONI GENEROSE PER MAXIMO, DIVANO MODULARE CON STRUTTURA IN RESINA RIGENERATA E TESSUTI AD ALTA COMPONENTE RICICLATA CHE, A PARTIRE DAL SINGOLO MODULO POLTRONA, PERMETTE INNUMEREVOLI CONFIGURAZIONI PROGETTUALI.

MAXIMO, THE MODULAR SOFA WITH A REGENERATED RESIN FRAME AND FABRICS CONTAINING MUCH RECYCLED MATERIAL, FEATURES CLEAN LINES AND GENEROUS DIMENSIONS. STARTING WITH A SINGLE ARMCHAIR MODULE, YOU CAN CREATE COUNTLESS DESIGN LAYOUTS.







MAXIMO terra / cannella Sunbrella® _ MAXIMO TAVOLINO terra



I CUSCINI AUTOCENTRANTI
VESTONO RICERCATE
TRAME TESSILI ALTAMENTE
PERFORMANTI PER
RESISTERE ALL'APERTO. TUTTI
SFODERABILI E LAVABILI.

*THE SELF-CENTRING CUSHIONS
ARE ADORNED WITH HIGH-
PERFORMANCE TEXTILES TO
WITHSTAND OUTDOOR USE.
THEY ALL HAVE WASHABLE
REMOVABLE COVERS.*



MAXIMO cactus / timo Sunbrella® _ MAXIMO TAVOLINO cactus



MAXIMO cactus / tino Sunbrella® _ MAXIMO PORTAOGGETTI cactus



LA COLLEZIONE MAXIMO
PREVEDE ANCHE UN PRATICO
PORTA-OGGETTI AGGANCIABILE
ALLA SEDUTA E UN TAVOLINO
D'APPOGGIO DOGATO.

THE MAXIMO COLLECTION
ALSO INCLUDES A PRACTICAL
ACCESSORY POCKET THAT CAN
BE ATTACHED TO THE SEAT, AND
A SLATTED LOW TABLE.



MAXIMO TAVOLINO cactus





MAXIMO gesso / perla Sunbrella®



MAXIMO TAVOLINO gesso





MAXIMO gesso / perla Sunbrella®





MAXIMO basalto / lava Sunbrella® _ MAXIMO TAVOLINO basalto



IL DESIGN SOBRIO E BILANCIATO DI MAXIMO SI SVILUPPA IN ORIZZONTALE, LA STRUTTURA È PIENA E RESA ESTETICAMENTE LEGGERA DALLA MODULAZIONE DELLE SEZIONI TRIANGOLARI E DAI DETTAGLI ARROTONDATI.

THE UNDERSTATED AND BALANCED DESIGN OF MAXIMO EXTENDS HORIZONTALLY. ITS STRUCTURE IS SOLID YET MADE AESTHETICALLY LIGHT WITH ITS MODULAR TRIANGULAR SECTIONS AND ROUNDED DETAILS.



MAXIMO POLTRONA basalto / lava Sunbrella®

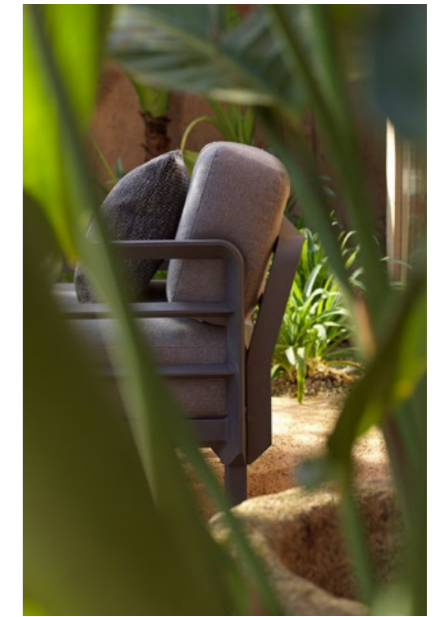

LA MODULARITÀ FLUIDA E ARMONICA, GRAZIE AL SISTEMA DI AGGANCO DI SCHIENALE E BRACCIOLO, PERMETTE OGNI INTERPRETAZIONE PROGETTUALE COME LA CONFORTEVOLE MAXIMO POLTRONA, CONFIGURABILE DA SOLA O IN COMPOSIZIONE.

WITH THE FIXING SYSTEM FOR BACKRESTS AND ARMRESTS, ITS HARMONIOUS AND FLUID MODULARITY OFFERS ALL POSSIBLE DESIGN INTERPRETATIONS, SUCH AS THE COMFORTABLE MAXIMO ARMCHAIR, WHICH CAN BE CONFIGURED ON ITS OWN OR IN A COMPOSITION.



KOMODO bianco / rosa quarzo _ KOMODO TAVOLINO bianco



KOMODO MODULAR SYSTEM

ISPIRATO ALLA NATURA E AGLI INTRECCI DEI RAMI DELLE PIANTE, KOMODO È UN SISTEMA MODULARE DI SEDUTE PER L'OUTDOOR CON STRUTTURA IN RESINA FIBERGLASS E IMBOTTITI DALLA STRAORDINARIA FLESSIBILITÀ COMPOSITIVA.

INSPIRED BY NATURE AND THE LATTICE PATTERN OF TREE BRANCHES, KOMODO IS A MODULAR SEATING SYSTEM FOR OUTDOOR ENVIRONMENTS, FEATURING A FIBERGLASS RESIN FRAME AND PADDED ELEMENTS WITH EXTRAORDINARY COMPOSITIONAL VERSATILITY.



KOMODO bianco / rosa quarzo _ KOMODO TAVOLINO bianco





IL CONCEPT DI KOMODO SI BASA SU
UNA STRUTTURA RETICOLARE STABILE
ALLA QUALE SONO AGGANCIABILI SU
TUTTI I LATI, ATTRAVERSO SEMPLICE
ROTAZIONE, GLI SCHIENALI.

*THE CONCEPT OF KOMODO IS BASED ON A
STABLE GRID FRAME, TO WHICH BACKRESTS
CAN BE ATTACHED ON ALL SIDES WITH A
SIMPLE ROTATING MOVEMENT.*



KOMODO POLTRONA agave / avocado - giungla Sunbrella®

KOMODO antracite / rosa quarzo _ KOMODO TAVOLINO VETRO antracite / vetro





KOMODO tortora / canvas Sunbrella® _ KOMODO TAVOLINO VETRO tortora / vetro

L'AMPIO E FUNZIONALE KOMODO TAVOLINO È PROPOSTO CON PIANO IN VETRO O IN RESINA FIBERGLASS IN PERFETTO PENDANT CON IL DIVANO MODULARE.

THE SPACIOUS AND FUNCTIONAL KOMODO TAVOLINO IS A LOW TABLE AVAILABLE WITH A GLASS OR FIBERGLASS RESIN TOP PERFECTLY MATCHING THE MODULAR SOFA.





KOMODO bianco / ghiaccio Sunbrella® _ KOMODO OMBRA 2 bianco / velo white _ KOMODO TAVOLINO bianco



archiproducts
AWARDS
WINNER
SUSTAINABILITY



TEVERE 147 EXTENSIBLE tortora _ TIBERINA BISTROT tortora

TEVERE SYSTEM

SOFISTICATA SOBRIETÀ STILISTICA, LINEE MORBIDE
GIOocate SULL'ASSENZA DI SPIGOLI E SULLA FORMA
ARROTONDATA DELLA STRUTTURA PER TEVERE,
TAVOLO DOGATO CON SISTEMA DI ALLUNGO CHE
MANTIENE LE GAMBE ALLE ESTREMITÀ DEL PIANO
PRESERVANDO UNA CURATA LINEA ESTETICA.

*SOPHISTICATED STYLISTIC SIMPLICITY, SOFT
LINES CENTRED ON THE ABSENCE OF SHARP
EDGES AND THE ROUNDED SHAPE OF THE FRAME
ARE THE DISTINCTIVE FEATURES OF TEVERE, A
SLATTED TABLE WITH AN EXTENSION SYSTEM THAT
KEEPS THE LEGS AT THE ENDS OF THE TOP WHILE
ENSURING A NEAT AESTHETIC LINE.*





TEVERE 147 EXTENSIBLE tortora _ TIBERINA BISTROT tortora

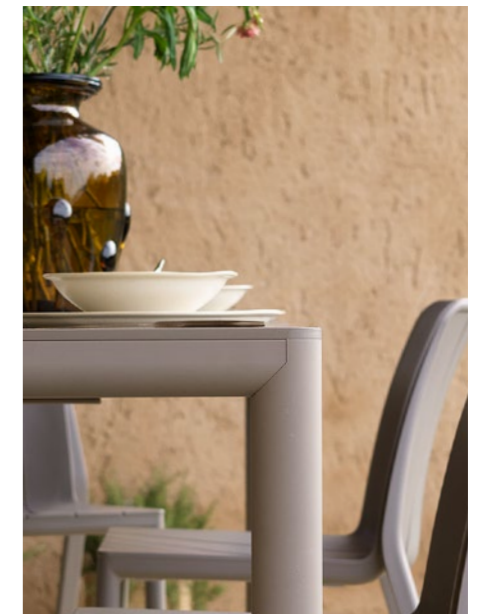
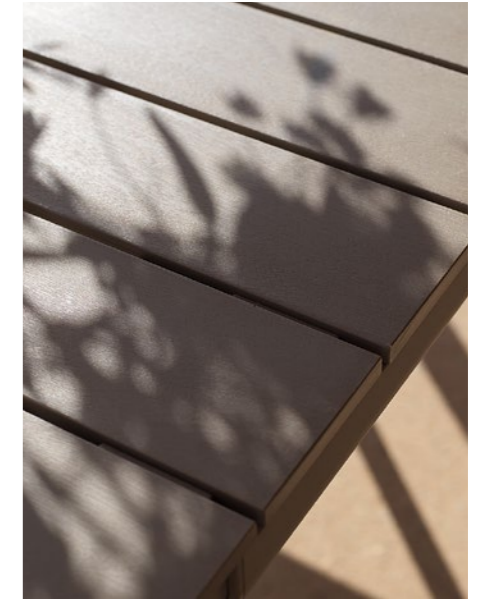

DOGHE, DESIGN FLUIDO, GAMBE AFFUSOLATE: SONO I CARDINI DELL'ELEGANTE SET COMPOSTO DAL TAVOLO ALLUNGABILE TEVERE E DALLA SEDUTA CON E SENZA BRACCIOLI TIBERINA.

SLATS, A FLUID DESIGN AND TAPERED LEGS: THESE ARE THE KEY FEATURES OF THE ELEGANT SET COMPRISING THE TEVERE EXTENSIBLE TABLE AND THE TIBERINA CHAIR WITH OR WITHOUT ARMRESTS.





TEVERE 210 EXTENSIBILE corda _ TIBERINA ARMCHAIR _ TIBERINA BISTROT corda





TEVERE 210 EXTENSIBILE corda _ DOGA ARMCHAIR _ DOGA BISTROT menta



TEVERE 210 EXTENSIBLE corda _ DOGA ARMCHAIR _ DOGA BISTROT menta

LA DINAMICITÀ DEL TAVOLO ALLUNGABILE
TEVERE INCONTRA L'EVOCATIVA
LEGGEREZZA DELLA COLLEZIONE DI
SEDUTE CON E SENZA BRACCIOLI DOGA.

*THE DYNAMIC APPEAL OF THE TEVERE
EXTENSIBLE TABLE MERGES WITH THE
IMPRESSIVE LIGHTNESS OF THE DOGA
COLLECTION OF CHAIRS WITH AND
WITHOUT ARMRESTS.*





TEVERE 210 EXTENSIBLE tortora
TRILL ARMCHAIR _ TRILL BISTROT rosa bouquet

STRUTTURE E FORME PIENE PER UNA STABILITÀ
IMPECCABILE, UNITE A UNA PIACEVOLE
FINITURA MAT: TEVERE SPOSA LA NATURALE
VOCAZIONE AL COMFORT DELLE SEDUTE TRILL.

*SOLID STRUCTURES AND SHAPES FOR
FLAWLESS STABILITY, COMBINED WITH AN
ATTRACTIVE MATT FINISH: TEVERE MATCHES
ITS NATURAL FUNCTION WITH THE COMFORT
OF TRILL CHAIRS.*





RIO ALU 210 EXTENSIBLE tortora _ DOGA ARMCHAIR _ DOGA BISTROT agave

RIO SYSTEM

CARATTERE DECISO E DESIGN PULITO PER IL TAVOLO ALLUNGABILE RIO CON PIANO IN RESINA DURELTOP E SOLIDA STRUTTURA IN ALLUMINIO VERNICIATO. DETTAGLI ARCHITETTURALI PER LA GAMBA A SEZIONE QUADRATA CHE SI INNESTA A FILO DEL PERIMETRO DEL PIANO, CONTRADDISTINTO DA UNA PERFETTA SEQUENZA DI DOGHE.

A DISTINCT CHARACTER AND A CLEAN DESIGN FOR THE RIO EXTENSIBLE TABLE WITH A DURELTOP RESIN TOP AND A STURDY, COATED ALUMINIUM FRAME. THE SQUARE-SECTION LEG FEATURES ARCHITECTURAL DETAILS WHILE FITTING FLUSH WITH THE PERIMETER OF THE TOP, FEATURING A PERFECT SEQUENCE OF SLATS.

L'ESSENZIALITÀ DELLE FORME DEL TAVOLO E LE GAMBE QUADRATE SPOSANO LE LINEE EQUILIBRATE E L'ASPETTO SCULTOREO DELLE SEDUTE CON E SENZA BRACCIOLI DELLA COLLEZIONE TRILL. ESTREMAMENTE CONFORTEVOLI, STABILI E VERSATILI PER L'UTILIZZO.

THE ESSENTIAL SHAPES OF THE TABLE AND SQUARE LEGS BLEND WITH THE BALANCED LINES AND THE SCULPTURAL APPEARANCE OF THE CHAIRS WITH AND WITHOUT ARMRESTS FROM THE TRILL COLLECTION. EXCEPTIONALLY COMFORTABLE, STABLE AND VERSATILE FOR USE.





RIO ALU 210 EXTENSIBLE antracite _ TRILL ARMCHAIR agave





RIO ALU 210 EXTENSIBILE antracite _ NET senape

IL VOLUME COMPATTO DEL TAVOLO SI
CONTRAPPONE ALLE TRASPARENZE DELLA
SCOCCA E ALLA RICERCATEZZA DEI COLORI
DELLA COLLEZIONE DI POLTRONCINE NET.

*THE COMPACT VOLUME OF THE TABLE
CONTRASTS WITH THE TRANSPARENCY OF
THE FRAME AND THE REFINED COLOURS OF
THE NET ARMCHAIR COLLECTION.*





RIO ALU 140 EXTENSIBLE bianco _ NET bianco / senape _ BIT bianco



RIO EXTENSIBLE bianco

RESIN TOP 25mm



RIO ALU EXTENSIBLE bianco

ALUMINIUM TOP 15mm

SET RIO BENCH ALU antracite



SET RIO BENCH ALU

—

ATMOSFERE INFORMALI E RILASSATE CON IL SET DOGATO COMPOSTO DA TAVOLO E PANCHE IN ALLUMINIO VERNICIATO CHE DEFINISCONO GLI AMBIENTI ESTERNI IN TOTALE LIBERTÀ. AMPIO E ROBUSTO, IL SET GIOCA SU UN DISEGNO PULITO E UN ASPETTO MATERICO PER UN RISULTATO CHE MASSIMIZZA DESIGN, COMFORT E FUNZIONALITÀ.

THE SLATTED SET CONSISTING OF A TABLE AND BENCHES IN COATED ALUMINIUM PROVIDES RELAXED AND INFORMAL ATMOSPHERES, ALLOWING YOU TO FREELY CREATE OUTDOOR ENVIRONMENTS. SPACIOUS AND STURDY, THE SET PLAYS ON A CLEAN DESIGN AND TEXTURED APPEARANCE RESULTING IN OPTIMISED DESIGN, COMFORT AND FUNCTIONALITY.





SET RIO BENCH ALU antracite

TAVOLO E PANCHE HANNO PIANI A DOGHE IN ALLUMINIO VERNICIATO CARATTERIZZATI DALLA PECULIARE TEXTURE RIGHETTATA. LE GAMBE QUADRATE IN ALLUMINIO SONO A FILO DEL PERIMETRO DEL PIANO E DELLA SEDUTA.

THE TABLE AND BENCHES FEATURE SLATTED TOPS IN COATED ALUMINIUM WITH A DISTINCTIVE RIBBED TEXTURE. THE SQUARE ALUMINIUM LEGS ARE FLUSH WITH THE PERIMETER OF THE TOP AND THE SEAT.



NET LOUNGE tortora _ SPRITZ tortora



NET COLLECTION

EQUILIBRIO DI FORME, PROPORZIONI E COLORI PER UNA RAFFINATA COLLEZIONE IN RESINA FIBERGLASS CON SEDUTE, POLTRONCINE, POLTRONE RELAX, DIVANETTO E TAVOLI D'APPOGGIO ADATTI ALLA PROGETTAZIONE DI PERSONALI SCENOGRAFIE OPEN AIR.

BALANCED SHAPES, PROPORTIONS AND COLOURS CREATE A SOPHISTICATED COLLECTION IN FIBERGLASS RESIN, WITH CHAIRS, ARMCHAIRS, RELAXING ARMCHAIRS, A SOFA AND LOW TABLES THAT ARE IDEAL FOR CREATING PERSONAL SETTINGS OUTDOORS.





NET LOUNGE antracite / grigio Sunbrella® _ SPRITZ antracite



LA SCOCCA OPACA E LEGGERMENTE BOMBATA È DECORATA DA UN MOTIVO A FORI QUADRATI DISTRIBUITI UNIFORMEMENTE SU TUTTA LA SUPERFICIE DELLE SEDUTE, *LEITMOTIV* DELLA COLLEZIONE INSIEME ALLA RICERCATA PALETTE DI COLORI. AMPIO IL VENTAGLIO DI CUSCINI PER SEDUTA E POGGIA-TESTA.

THE MATT, SLIGHTLY ROUNDED STRUCTURE IS ADORNED WITH A SQUARE PERFORATED PATTERN EXTENDING EVENLY ACROSS THE ENTIRE SURFACE OF THE CHAIRS, A HALLMARK OF THE COLLECTION ALONG WITH THE SOPHISTICATED COLOUR PALETTE. A WIDE RANGE OF CUSHIONS IS AVAILABLE FOR THE CHAIRS AND HEADREST.



NET LOUNGE corallo _ SPRITZ tortora





NET LOUNGE senape _ SPRITZ tortora





NET RELAX salice / sardinia _ NET TABLE 100 salice



NET BENCH corallo / rosa quarzo _ NET RELAX corallo / rosa quarzo
NET TABLE 100 corallo





DOGA RELAX antracite / fumo Sunbrella® _ DOGA TABLE antracite

DOGA COLLECTION

LEGGEREZZA E FUNZIONALITÀ PER DOGA, COLLEZIONE DI SEDUTE CON TAVOLINO ISPIRATA AL TEMA DELLA DOGA RIVISITATA IN CHIAVE CONTEMPORANEA. L'INEDITO RANGE CROMATICO E IL NATURALE GIOCO DI PIENI E DI VUOTI OFFRONO INTRIGANTI POSSIBILITÀ D'ARREDO ALL'ARIA APERTA.

LIGHTNESS AND FUNCTIONALITY ARE THE HALLMARKS OF DOGA, A COLLECTION OF CHAIRS WITH A LOW TABLE INSPIRED BY A SLATTED DESIGN GIVEN A CONTEMPORARY TWIST. THE INNOVATIVE COLOUR RANGE AND THE NATURAL INTERPLAY OF OPEN AND CLOSED SPACES OFFER FASCINATING OPPORTUNITIES FOR FURNISHING OUTDOOR ENVIRONMENTS.



DOGA RELAX antracite / fumo Sunbrella® _ DOGA TABLE antracite





DOGA BISTROT _ DOGA ARMCHAIR _ DOGA RELAX marsala / mattone



DOGA ARMCHAIR pera - marsala - cappuccino



DOGA RELAX cappuccino - agave _ DOGA TABLE agave



FOLIO tortora / lino _ POGGIO tortora



FOLIO COLLECTION

ELEGANTE E AVVOLGENTE ABBRACCIO
STRUTTURALE PER LA POLTRONA RELAX
FOLIO, RECLINABILE IN DUE POSIZIONI E
PROPOSTA CON BASE FISSA O A DONDOLO.

*THE FOLIO RELAXING ARMCHAIR OFFERS AN
ELEGANT AND ENVELOPING STRUCTURAL
EMBRACE, RECLINES TO TWO POSITIONS AND IS
AVAILABLE WITH A FIXED OR ROCKING BASE.*





FOLIO tortora / felce Sunbrella® _ POGGIO tortora

ATLANTICO

PROGETTATO SU UNO SLANCIATO ARCO PORTANTE CHE CARATTERIZZA TUTTA LA STRUTTURA, ATLANTICO È UN LETTINO PRENDISOLE DELINEATO DA FORME ARROTONDATE. MASSIMA CURA DEI DETTAGLI E QUALITÀ DEI MATERIALI PER UN CONCEPT ESTETICO DAI TRATTI PURI ED ESSENZIALI, APPOSITAMENTE STUDIATI PER GARANTIRE UNA PERFETTA ERGONOMIA E UN BILANCIAMENTO UNIFORME DEL PESO.

DESIGNED WITH A SLENDER LOAD-BEARING ARCH SHAPE THAT IS A DISTINCTIVE FEATURE OF ITS ENTIRE FRAME, ATLANTICO IS A SUNLOUNGER WITH ROUNDED SHAPES. THE UTMOST ATTENTION TO DETAILS AND HIGH-QUALITY MATERIALS RESULT IN AN AESTHETIC CONCEPT WITH PURE AND ESSENTIAL FEATURES, SPECIFICALLY DESIGNED TO ENSURE OPTIMAL ERGONOMICS AND UNIFORM DISTRIBUTION OF WEIGHT.







ATLANTICO tortora / tortora _ POP tortora





ATLANTICO tortora / agave

STRUTTURA IN RESINA FIBERGLASS, TESSUTO
TRASPIRANTE E SCHIENALE RECLINABILE IN
QUATTRO DIVERSE POSIZIONI PER UN TOTALE
ABBANDONO AL RELAX.

*A FIBERGLASS RESIN FRAME, BREATHABLE
FABRIC AND A BACKREST RECLINING TO
FOUR DIFFERENT POSITIONS PROVIDE TOTAL
RELAXATION.*





ATLANTICO bianco / bianco _ POP bianco

TECHNICAL

DETAILS



regeneration

Nardi produce arredi per l'outdoor studiati per il benessere e il relax delle persone. Lavorare al fine di rendere i processi sempre più sostenibili è parte integrante della filosofia dell'azienda che nel 2019 ha inaugurato il programma industriale Regeneration dedicato alla produzione di arredamenti per esterno in plastica post consumo. Nello stesso anno ha introdotto le analisi LCA su diversi prodotti per mettere progressivamente in atto ulteriori azioni per migliorare le proprie performance ambientali.

Come tutta la gamma di arredi, anche quelli del catalogo Regeneration sono realizzati in impianti progettati con tecnologie all'avanguardia dal punto di vista dell'ecosostenibilità. Tutti gli stabilimenti utilizzano esclusivamente energia elettrica 100% green proveniente da fonti rinnovabili certificate insieme a quella generata dal proprio sistema di pannelli fotovoltaici.

Sempre in ottica ecologica, gli imballi di protezione sono in cartone certificato FSC® e polietilene a bassa densità completamente riciclabile, entrambi concepiti per essere ridotti al minimo. Le scafole contenitive di cartone sono composte mediamente dal 75% di fibre riciclate, con l'impiego di amido di mais come collante. Diverse sono, inoltre, le iniziative dell'azienda a favore di un corretto utilizzo e smaltimento degli imballaggi e dei bancali per il trasporto.

Nardi produces outdoor furniture tailored to people's well-being and relaxation. Working to make processes increasingly sustainable is an integral part of the philosophy of our company which, in 2019, launched the Regeneration industrial programme dedicated to producing outdoor furniture in post-consumer plastic. In the same year, Nardi introduced LCA analysis on several products to gradually implement further actions to improve its environmental performance.

Like the entire range, the furniture in the Regeneration catalogue is made in production plants designed with state-of-the-art technology based on eco-sustainability. All production plants exclusively use 100% green electricity from certified renewable sources together with electricity generated by their own photovoltaic panel system.

Also in keeping with an eco-friendly perspective, protective packaging is made of FSC®-certified cardboard and fully recyclable low-density polyethylene, which are both designed to be minimised. On average, cardboard boxes are made of 75% recycled fibres, with maize starch used as glue. Several of our company initiatives also support the correct use and disposal of packaging and transport pallets.

For more information visit www.nardioutdoor.com/regeneration

MAXIMO

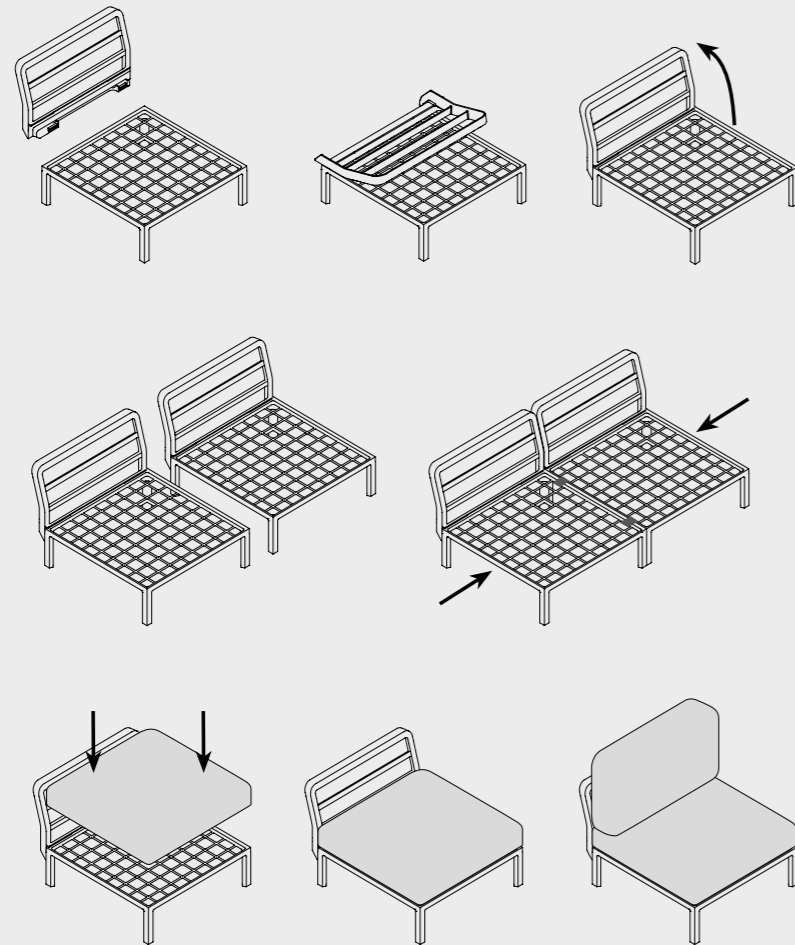

MAXIMO è un sistema modulare di sedute configurabile a piacere. I moduli possono essere fissati tra loro e gli schienali e i braccioli sono agganciabili su tutti i lati della seduta.

Oltre alla versione MAXIMO 5, è possibile configurare e ordinare la tua versione personalizzata elencando tutti i singoli elementi che la formano.

MAXIMO is a modular system of upholstered seats which can be configured to suit your particular needs. The modules can be secured to one another and the backrests and armrests can be attached on all sides of the seat.

In addition to the MAXIMO 5 version, you can configure and order your own customized version simply by listing all the individual elements you require.

MAXIMO POLTRONA **new**

regenerated fiberglass polypropylene
recycled fabric

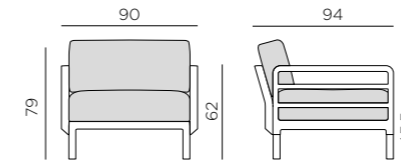

18,3 kg
n. pz. 1



MAXIMO ELEMENTO TERMINALE **new**

regenerated fiberglass polypropylene
recycled fabric

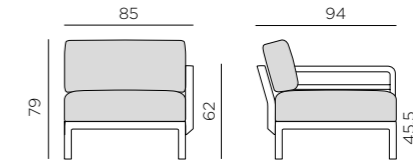

16,2 kg
n. pz. 1



MAXIMO ELEMENTO CENTRALE **new**

regenerated fiberglass polypropylene
recycled fabric

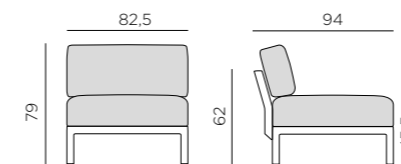

14 kg
n. pz. 1



MAXIMO ELEMENTO ANGOLO **new**

regenerated fiberglass polypropylene
recycled fabric

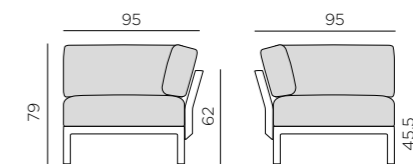

18,3 kg
n. pz. 1



MAXIMO POUF **new**

regenerated fiberglass polypropylene
recycled fabric

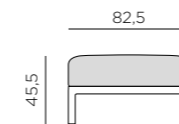

10 kg
n. pz. 1



MAXIMO 5 **new**

regenerated fiberglass polypropylene
recycled fabric

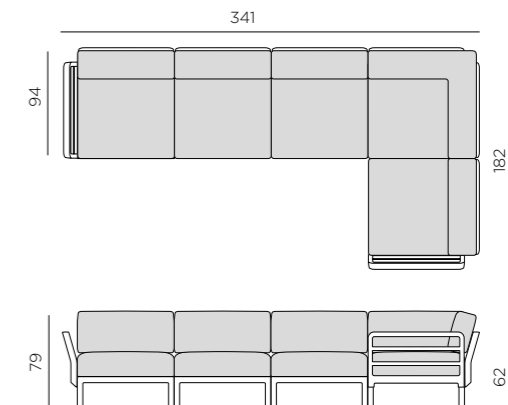

78,2 kg
n. pz. 1

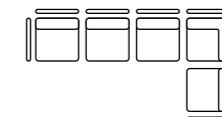

Maximo 5 è composto da 5 sedute e 8 schienali
Maximo 5 consists of 5 seats and 8 backrests

new



POLTRONA



ELEMENTO
TERMINALE



ELEMENTO
CENTRALE



ELEMENTO
ANGOLO



POUF



MAXIMO 5

TERRA
cannella
Sunbrella®



40181.44.219

40182.44.219

40183.44.219

40184.44.219

40179.44.219

40180.44.219

GESSO
cannella
Sunbrella®



40181.29.219

40182.29.219

40183.29.219

40184.29.219

40179.29.219

40180.29.219

CACTUS
cannella
Sunbrella®



40181.27.219

40182.27.219

40183.27.219

40184.27.219

40179.27.219

40180.27.219

BASALTO
cannella
Sunbrella®



40181.25.219

40182.25.219

40183.25.219

40184.25.219

40179.25.219

40180.25.219

TERRA
perla
Sunbrella®



40181.44.213

40182.44.213

40183.44.213

40184.44.213

40179.44.213

40180.44.213

GESSO
perla
Sunbrella®



40181.29.213

40182.29.213

40183.29.213

40184.29.213

40179.29.213

40180.29.213

CACTUS
perla
Sunbrella®



40181.27.213

40182.27.213

40183.27.213

40184.27.213

40179.27.213

40180.27.213

BASALTO
perla
Sunbrella®



40181.25.213

40182.25.213

40183.25.213

40184.25.213

40179.25.213

40180.25.213

new



POLTRONA



ELEMENTO
TERMINALE



ELEMENTO
CENTRALE



ELEMENTO
ANGOLO



POUF



MAXIMO 5

TERRA
timo
Sunbrella®



40181.44.217

40182.44.217

40183.44.217

40184.44.217

40179.44.217

40180.44.217

GESSO
timo
Sunbrella®



40181.29.217

40182.29.217

40183.29.217

40184.29.217

40179.29.217

40180.29.217

CACTUS
timo
Sunbrella®



40181.27.217

40182.27.217

40183.27.217

40184.27.217

40179.27.217

40180.27.217

BASALTO
timo
Sunbrella®



40181.25.217

40182.25.217

40183.25.217

40184.25.217

40179.25.217

40180.25.217

TERRA
lava
Sunbrella®



40181.44.215

40182.44.215

40183.44.215

40184.44.215

40179.44.215

40180.44.215

GESSO
lava
Sunbrella®

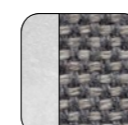

40181.29.215

40182.29.215

40183.29.215

40184.29.215

40179.29.215

40180.29.215

CACTUS
lava
Sunbrella®

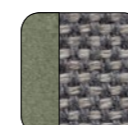

40181.27.215

40182.27.215

40183.27.215

40184.27.215

40179.27.215

40180.27.215

BASALTO
lava
Sunbrella®

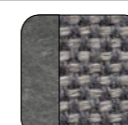

40181.25.215

40182.25.215

40183.25.215

40184.25.215

40179.25.215

40180.25.215

Il polipropilene fiberglass rigenerato e il tessuto rigenerato Sunbrella possono presentare delle variazioni di colore dovute all'utilizzo di materiale riciclato - Regenerated fiberglass polypropylene and Sunbrella regenerated fabric may vary in color due to the use of recycled material - Polypropylène fiberglass régénéré et le tissu régénéré Sunbrella peuvent présenter variations de couleur en raison de l'utilisation de matériaux recyclés - Regeneriertem fiberglass-Polypropylen und das regenerierte Gewebe Sunbrella können aufgrund der Verwendung von recyceltem Material Farbunterschiede aufweisen - El polipropileno fiberglass regenerado y el tejido regenerado Sunbrella pueden presentar variaciones de color debido al uso de material reciclado - O polipropileno fiberglass regenerado e o tecido regenerado Sunbrella podem apresentar variações de cor devido ao uso de material reciclado - Polipropilen fiberglass ve Sunbrella rejenere kumaş, geri dönüştürülmüş malzeme kullanımı nedeniyle renk farklılıkları gösterebilir - цвет регенерированного полипропиленового стекловолокна и регенерированной ткани Sunbrella может иметь отличия вследствие использования переработанного материала

MAXIMO TAVOLINO **new**

regenereted fiberglass polypropylene

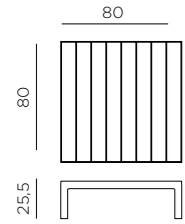

10,8 kg
n. pz. 1



TERRA
40178.44.000



GESSO
40178.29.000

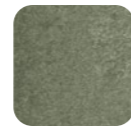

CACTUS
40178.27.000

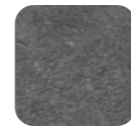

BASALTO
40178.25.000

MAXIMO PORTAOGGETTI **new**

regenereted fiberglass polypropylene

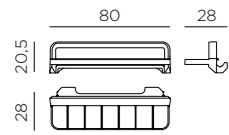

3,1 kg
n. pz. 1



TERRA
40188.44.000



GESSO
40188.29.000

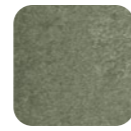

CACTUS
40188.27.000

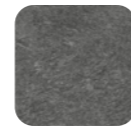

BASALTO
40188.25.000

MAXIMO BRACCIOLO **new**

regenereted fiberglass polypropylene

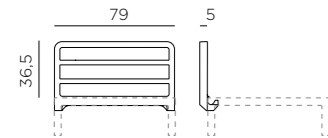

2,4 kg
n. pz. 2



TERRA
40185.44.000



GESSO
40185.29.000

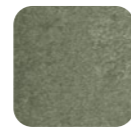

CACTUS
40185.27.000

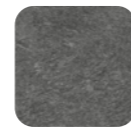

BASALTO
40185.25.000

MAXIMO SCHIENALE **new**

regenereted fiberglass polypropylene

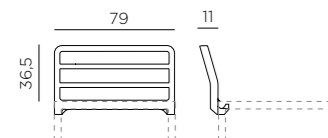

2,5 kg
n. pz. 4



TERRA
40186.44.000



GESSO
40186.29.000

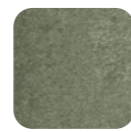

CACTUS
40186.27.000

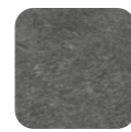

BASALTO
40186.25.000

CUSCINO SCHIENALE MAXIMO **new**

recycled fabric

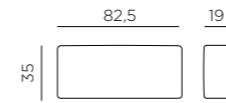

1,4 kg
n. pz. 1

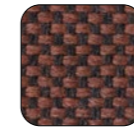

cannella
Sunbrella®
36180.52.219



perla
Sunbrella®
36180.52.213



timo
Sunbrella®
36180.52.217



lava
Sunbrella®
36180.52.215

CUSCINO SCHIENALE ANGOLO MAXIMO **new**

recycled fabric

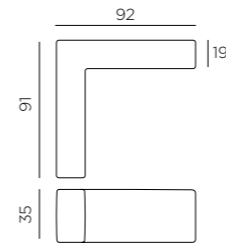

2,8 kg
n. pz. 1



cannella
Sunbrella®
36180.54.219



perla
Sunbrella®
36180.54.213



timo
Sunbrella®
36180.54.217



lava
Sunbrella®
36180.54.215

Il polipropilene fiberglass rigenerato e il tessuto rigenerato Sunbrella possono presentare delle variazioni di colore dovute all'utilizzo di materiale riciclato - Regenerated fiberglass polypropylene and Sunbrella regenerated fabric may vary in color due to the use of recycled material - Polypropylène fiberglass régénéré et le tissu régénéré Sunbrella peuvent présenter variations de couleur en raison de l'utilisation de matériaux recyclés - Regeneriertem fiberglass-Polypropylen und das regenerierte Gewebe Sunbrella können aufgrund der Verwendung von recyceltem Material Farbunterschiede aufweisen - El polipropileno fiberglass regenerado y el tejido regenerado Sunbrella pueden presentar variaciones de color debido al uso de material reciclado - O polipropileno fiberglass regenerado e o tecido regenerado Sunbrella podem apresentar variações de cor devido ao uso de material reciclado - Polipropilen fiberglass ve Sunbrella rejenere kumaş, geri dönüştürülmüş malzeme kullanımı nedeniyle renk farklılıkları gösterebilir - цвет регенерированного полипропиленового стекловолокна и регенерированной ткани Sunbrella может иметь отличия вследствие использования переработанного материала

CUSCINO ARREDO MAXIMO 50X50 **new**

recycled fabric

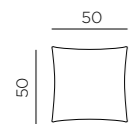

0,8 kg
n. pz. 4



cannella arredo
Sunbrella®
36180.01.220



perla arredo
Sunbrella®
36180.01.214

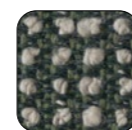

timo arredo
Sunbrella®
36180.01.218



lava arredo
Sunbrella®
36180.01.216

CUSCINO ARREDO MAXIMO 60X40 **new**

recycled fabric

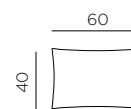

0,9 kg
n. pz. 4



cannella arredo
Sunbrella®
36180.02.220



perla arredo
Sunbrella®
36180.02.214

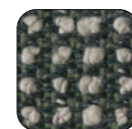

timo arredo
Sunbrella®
36180.02.218

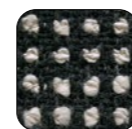

lava arredo
Sunbrella®
36180.02.216

CUSCINO ARREDO MAXIMO 70X30 **new**

recycled fabric



0,7 kg
n. pz. 4



cannella arredo
Sunbrella®
36180.03.220



perla arredo
Sunbrella®
36180.03.214



timo arredo
Sunbrella®
36180.03.218

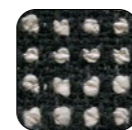

lava arredo
Sunbrella®
36180.03.216

KOMODO

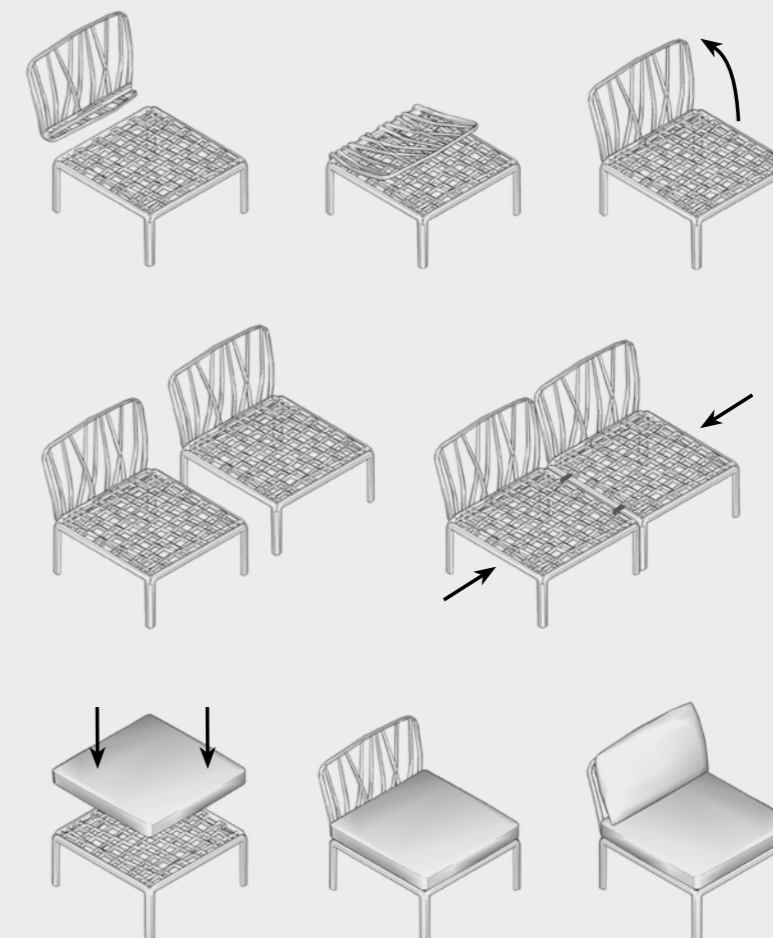

KOMODO è un sistema modulare di sedute configurabile a piacere. I moduli possono essere fissati tra loro e gli schienali e i braccioli sono agganciabili su tutti i lati della seduta. Oltre alla versione KOMODO 5, è possibile configurare e ordinare la tua versione personalizzata elencando tutti i singoli elementi che la formano.

KOMODO is a modular system of upholstered seats which can be configured to suit your particular needs. The modules can be secured to one another and the backrests and armrests can be attached on all sides of the seat. In addition to the KOMODO 5 version, you can configure and order your own customized version simply by listing all the individual elements you require.

Il tessuto rigenerato Sunbrella può presentare delle variazioni di colore dovute all'utilizzo di materiale riciclato - The Sunbrella regenerated fabric may vary in color due to the use of recycled material - Le tissu régénéré Sunbrella peut présenter variations de couleur en raison de l'utilisation de matériaux recyclés - Das regenerierte Gewebe Sunbrella kann aufgrund der Verwendung von recyceltem Material Farbunterschiede aufweisen - El tejido regenerado Sunbrella puede presentar variaciones de color debido al uso de material reciclado - O tecido regenerado Sunbrella pode apresentar variações de cor devido ao uso de material reciclado - Sunbrella rejenere kumaş, geri dönüştürülmüş malzeme kullanımı nedeniyle renk farklılıkları gösterebilir - цвет регенерированной ткани Sunbrella может иметь отличия вследствие использования переработанного материала

KOMODO POLTRONA

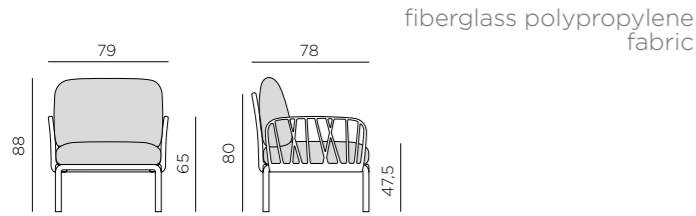

14,3 kg
n. pz. 1

KOMODO ELEMENTO TERMINALE DX/SX

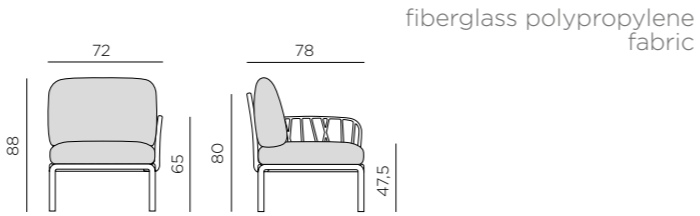

12,6 kg
n. pz. 1

KOMODO ELEMENTO CENTRALE

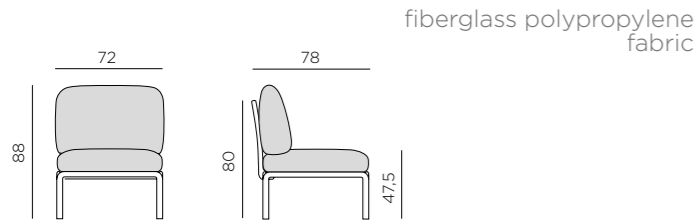

10,9 kg
n. pz. 1

KOMODO ELEMENTO ANGOLO

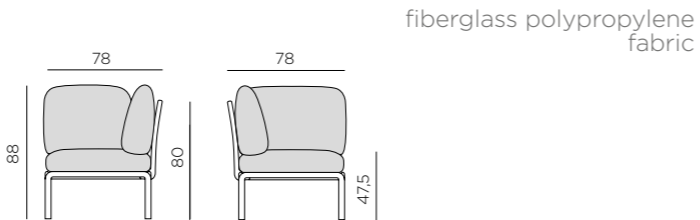

14 kg
n. pz. 1

KOMODO POUF

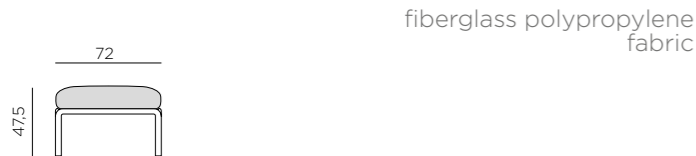

7,5 kg
n. pz. 1

KOMODO 5

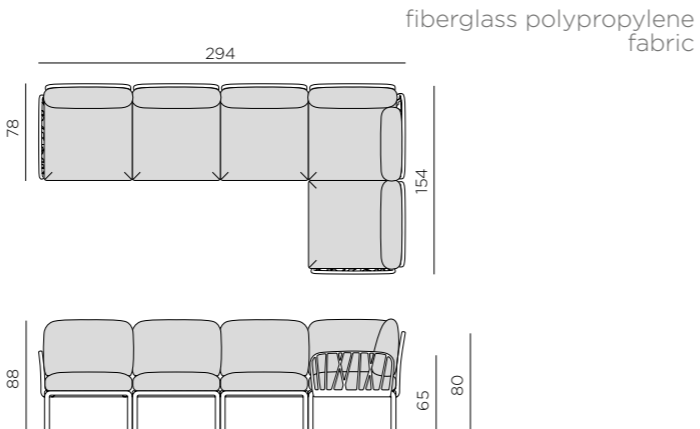

61 kg
n. pz. 1



POLTRONA



ELEMENTO
TERMINALE
DX/SX



ELEMENTO
CENTRALE



ELEMENTO
ANGOLO



POUF

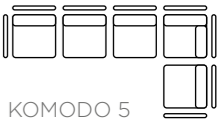

KOMODO 5

BIANCO rosa quarzo #		40371.00.066	40372.00.066	40373.00.066	40374.00.066	40369.00.066	40370.00.066
ANTRACITE rosa quarzo #		40371.02.066	40372.02.066	40373.02.066	40374.02.066	40369.02.066	40370.02.066
TORTORA rosa quarzo #		40371.10.066	40372.10.066	40373.10.066	40374.10.066	40369.10.066	40370.10.066
AGAVE rosa quarzo #		40371.16.066	40372.16.066	40373.16.066	40374.16.066	40369.16.066	40370.16.066
BIANCO grigio Komodo		40371.00.172	40372.00.172	40373.00.172	40374.00.172	40369.00.172	40370.00.172
ANTRACITE grigio Komodo		40371.02.172	40372.02.172	40373.02.172	40374.02.172	40369.02.172	40370.02.172
TORTORA grigio Komodo		40371.10.172	40372.10.172	40373.10.172	40374.10.172	40369.10.172	40370.10.172
AGAVE grigio Komodo		40371.16.172	40372.16.172	40373.16.172	40374.16.172	40369.16.172	40370.16.172



Life Cycle Assessment

For more information visit: www.nardioutdoor.com/sustainability

Variazioni di colore sono da ritenersi standard e naturali nei tessuti acrilici tinto filo. Posizionare in zone d'ombra - Colour variations are to be considered standard and natural in yarn-dyed acrylic fabrics. Position in shaded areas - Les variations de couleur des tissus acryliques au fil teint sont standard et naturelles. Placer dans des zones ombragées - Farbveränderungen sind als Standard und in im Garn gefärbten Acrylgeweben als natürlich zu betrachten. In schattigen Bereichen aufstellen - Las variaciones de color son normales y naturales en las telas acrílicas teñidas en hilo. Colocar en zonas de sombra - As variações de cor são consideradas standard e naturais nos tecidos acrílico tingidos com fio. Posicionar em zonas de sombra - Boyalı akrilik iplik kumaşlarda renk değişiklikleri standart ve doğal kabul edilir. Gölge alanlara yerleştiriniz - Изменения цвета следует считать нормой, они являются естественными в случае акриловых тканей с окрашенными волокнами. Размещать в тени



	POLTRONA	ELEMENTO TERMINALE DX/SX	ELEMENTO CENTRALE	ELEMENTO ANGOLO	POUF	KOMODO 5
BIANCO adriatic Sunbrella® *		40371.00.142	40372.00.142	40373.00.142	40374.00.142	40369.00.142 40370.00.142
ANTRACITE adriatic Sunbrella® *		40371.02.142	40372.02.142	40373.02.142	40374.02.142	40369.02.142 40370.02.142
TORTORA adriatic Sunbrella® *		40371.10.142	40372.10.142	40373.10.142	40374.10.142	40369.10.142 40370.10.142
AGAVE adriatic Sunbrella® *		40371.16.142	40372.16.142	40373.16.142	40374.16.142	40369.16.142 40370.16.142

BIANCO ghiaccio Sunbrella® *		40371.00.138	40372.00.138	40373.00.138	40374.00.138	40369.00.138 40370.00.138
ANTRACITE ghiaccio Sunbrella® *		40371.02.138	40372.02.138	40373.02.138	40374.02.138	40369.02.138 40370.02.138
TORTORA ghiaccio Sunbrella® *		40371.10.138	40372.10.138	40373.10.138	40374.10.138	40369.10.138 40370.10.138
AGAVE ghiaccio Sunbrella® *		40371.16.138	40372.16.138	40373.16.138	40374.16.138	40369.16.138 40370.16.138



	POLTRONA	ELEMENTO TERMINALE DX/SX	ELEMENTO CENTRALE	ELEMENTO ANGOLO	POUF	KOMODO 5
BIANCO avocado Sunbrella® *		40371.00.139	40372.00.139	40373.00.139	40374.00.139	40369.00.139 40370.00.139
ANTRACITE avocado Sunbrella® *		40371.02.139	40372.02.139	40373.02.139	40374.02.139	40369.02.139 40370.02.139
TORTORA avocado Sunbrella® *		40371.10.139	40372.10.139	40373.10.139	40374.10.139	40369.10.139 40370.10.139
AGAVE avocado Sunbrella® *		40371.16.139	40372.16.139	40373.16.139	40374.16.139	40369.16.139 40370.16.139

BIANCO giungla Sunbrella® *		40371.00.140	40372.00.140	40373.00.140	40374.00.140	40369.00.140 40370.00.140
ANTRACITE giungla Sunbrella® *		40371.02.140	40372.02.140	40373.02.140	40374.02.140	40369.02.140 40370.02.140
TORTORA giungla Sunbrella® *		40371.10.140	40372.10.140	40373.10.140	40374.10.140	40369.10.140 40370.10.140
AGAVE giungla Sunbrella® *		40371.16.140	40372.16.140	40373.16.140	40374.16.140	40369.16.140 40370.16.140

Il tessuto rigenerato Sunbrella può presentare delle variazioni di colore dovute all'utilizzo di materiale riciclato - The Sunbrella regenerated fabric may vary in color due to the use of recycled material - Le tissu régénéré Sunbrella peut présenter variations de couleur en raison de l'utilisation de matériaux recyclés - Das regenerierte Gewebe Sunbrella kann aufgrund der Verwendung von recyceltem Material Farbunterschiede aufweisen - El tejido regenerado Sunbrella puede presentar variaciones de color debido al uso de material reciclado - O tecido regenerado Sunbrella pode apresentar variações de cor devido ao uso de material reciclado - Sunbrella rejenere kumaş, geri dönüştürülmüş malzeme kullanımı nedeniyle renk farklılıkları gösterebilir - цвет регенерированной ткани Sunbrella может иметь отличия вследствие использования переработанного материала

* Trattamento laminato su richiesta con quantità minima - Laminated finish available on request with a minimum quantity - Traitement laminé sur demande avec une quantité minimum - Laminierte Ausrüstung auf Anfrage mit einer Mindestmenge - Tratamiento laminado bajo pedido con una cantidad mínima - Tratamento laminado sob encomenda com quantidade mínima - Talep üzerine minimum miktarda lamine işlem - Ламинированная обработка по запросу с минимальным количеством



	POLTRONA	ELEMENTO TERMINALE DX/SX	ELEMENTO CENTRALE	ELEMENTO ANGOLO	POUF	KOMODO 5
BIANCO canvas Sunbrella® *		40371.00.141	40372.00.141	40373.00.141	40374.00.141	40369.00.141 40370.00.141
ANTRACITE canvas Sunbrella® *		40371.02.141	40372.02.141	40373.02.141	40374.02.141	40369.02.141 40370.02.141
TORTORA canvas Sunbrella® *		40371.10.141	40372.10.141	40373.10.141	40374.10.141	40369.10.141 40370.10.141
AGAVE canvas Sunbrella® *		40371.16.141	40372.16.141	40373.16.141	40374.16.141	40369.16.141 40370.16.141

BIANCO TECH panama		40371.00.131	40372.00.131	40373.00.131	40374.00.131	40369.00.131 40370.00.131
ANTRACITE TECH panama		40371.02.131	40372.02.131	40373.02.131	40374.02.131	40369.02.131 40370.02.131
TORTORA TECH panama		40371.10.131	40372.10.131	40373.10.131	40374.10.131	40369.10.131 40370.10.131
AGAVE TECH panama		40371.16.131	40372.16.131	40373.16.131	40374.16.131	40369.16.131 40370.16.131

Tessuti disponibili su ordinazione per minimi quantitativi d'ordine - Fabrics available to order for minimum order quantities - Tissus disponibles sur commande de quantités minimales - Gewebe auf Bestellung für Mindestbestellmengen erhältlich - Telas disponibles bajo pedido para cantidades mínimas - Tecidos disponíveis por encomenda para quantidades mínimas de encomenda - Minimum sipariş miktarına göre sipari verilebilecek mevcut kumaşlar - ткани на заказ для минимального объема заказа.

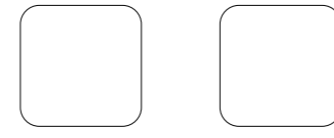

Sunbrella® + EXTRA * p.164-165
Nardi Acrylic # p.167

Variazioni di colore sono da ritenersi standard e naturali nei tessuti acrilici tinto filo. Posizionare in zone d'ombra - Colour variations are to be considered standard and natural in yarn-dyed acrylic fabrics. Position in shaded areas - Les variations de couleur des tissus acryliques au fil teint sont standard et naturelles. Placer dans des zones ombragées - Farbveränderungen sind als Standard und in im Garn gefärbten Acrylgeweben als natürlich zu betrachten. In schattigen Bereichen aufstellen - Las variaciones de color son normales y naturales en las telas acrílicas teñidas en hilo. Colocar en zonas de sombra - As variações de cor são consideradas standard e naturais nos tecidos acrílico tingidos com fio. Posicionar em zonas de sombra - Boyalı akrilik iplik kumaşlarda renk değişiklikleri standart ve doğal kabul edilir. Gölge alanlara yerleştiriniz - Изменения цвета следует считать нормой, они являются естественными в случае акриловых тканей с окрашенными волокнами. Размещать в тени

* Trattamento laminato su richiesta con quantità minima - Laminated finish available on request with a minimum quantity - Traitement laminé sur demande avec une quantité minimum - Laminierte Ausrüstung auf Anfrage mit einer Mindestmenge - Tratamiento laminado bajo pedido con una cantidad mínima - Tratamento laminado sob encomenda com quantidade mínima - Talep üzerine minimum miktarda lamine işlem - Ламинированная обработка по запросу с минимальным количеством

KOMODO OMBRA 3

fiberglass polypropylene / fabric

BIANCO velo white 40408.00.203
ANTRACITE velo white 40408.02.203
TORTORA velo white 40408.10.203
AGAVE velo white 40408.16.203

4,7 kg
n. pz. 1

KOMODO OMBRA 2

fiberglass polypropylene / fabric

BIANCO velo white 40407.00.203
ANTRACITE velo white 40407.02.203
TORTORA velo white 40407.10.203
AGAVE velo white 40407.16.203

4,6 kg
n. pz. 1

KOMODO TAVOLINO

fiberglass polypropylene

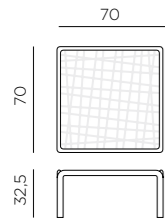

6,7 kg
n. pz. 1



BIANCO 40378.00.000 ANTRACITE 40378.02.000
TORTORA 40378.10.000 AGAVE 40378.16.000

KOMODO TAVOLINO VETRO

fiberglass polypropylene / glass

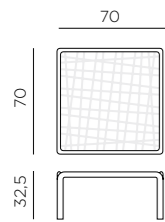

11,4 kg
n. pz. 1



BIANCO vetro 40368.00.501 ANTRACITE vetro 40368.02.501
TORTORA vetro 40368.10.501 AGAVE vetro 40368.16.501

KOMODO BRACCIOLO

fiberglass polypropylene

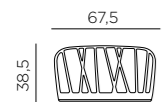

1,7 kg
n. pz. 2



BIANCO 40375.00.000 ANTRACITE 40375.02.000
TORTORA 40375.10.000 AGAVE 40375.16.000

KOMODO SCHIENALE

fiberglass polypropylene

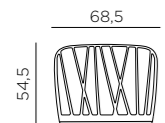

2 kg
n. pz. 4



BIANCO 40376.00.000 ANTRACITE 40376.02.000
TORTORA 40376.10.000 AGAVE 40376.16.000

CUSCINO SCHIENALE KOMODO

fabric

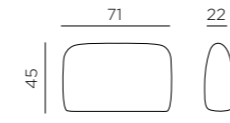

1,4 kg
n. pz. 1



rosa quarzo #
36370.52.066



grigio komodo
36370.52.172

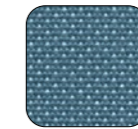

adriatic Sunbrella® *
36370.52.142

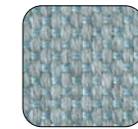

ghiaccio Sunbrella® *
36370.52.138



avocado Sunbrella® *
36370.52.139



giungla Sunbrella® *
36370.52.140



canvas Sunbrella® *
36370.52.141



TECH panama
36370.52.131

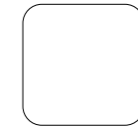

Sunbrella® + EXTRA ▲
p. 164-165

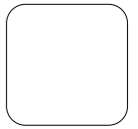

Nardi Acrylic ▲
p. 167

CUSCINO SCHIENALE ANGOLO KOMODO

fabric

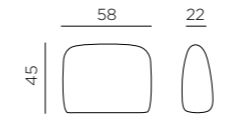

1,1 kg
n. pz. 1



rosa quarzo #
36370.54.066



grigio komodo
36370.54.172

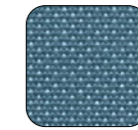

adriatic Sunbrella® *
36370.54.142

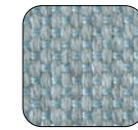

ghiaccio Sunbrella® *
36370.54.138



avocado Sunbrella® *
36370.54.139



giungla Sunbrella® *
36370.54.140



canvas Sunbrella® *
36370.54.141



TECH panama
36370.54.131

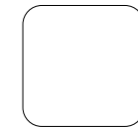

Sunbrella® + EXTRA ▲
p. 164-165

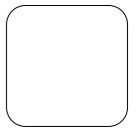

Nardi Acrylic ▲
p. 167

▲ Sunbrella® e Sunbrella® EXTRA - p. 164-165 Nardi Acrylic - p. 167

Tessuti disponibili su ordinazione per minimi quantitativi d'ordine - Fabrics available to order for minimum order quantities - Tissus disponibles sur commande de quantités minimales - Gewebe auf Bestellung für Mindestbestellmengen erhältlich - Telas disponibles bajo pedido para cantidades mínimas - Tecidos disponíveis por encomenda para quantidades mínimas de encomenda - Minimum sipariş miktarına göre sipari verilebilecek mevcut kumaşlar - ткани на заказ для минимального объема заказа

Variazioni di colore sono da ritenersi standard e naturali nei tessuti acrilici tinto filo. Posizionare in zone d'ombra - Colour variations are to be considered standard and natural in yarn-dyed acrylic fabrics. Position in shaded areas - Les variations de couleur des tissus acryliques au fil teint sont standard et naturelles. Placer dans des zones ombragées - Farbveränderungen sind als Standard und in im Garn gefärbten Acrylgeweben als natürlich zu betrachten. In schattigen Bereichen aufstellen - Las variaciones de color son normales y naturales en las telas acrílicas teñidas en hilo. Colocar en zonas de sombra - As variações de cor são consideradas standard e naturais nos tecidos acrílico tingidos com fio. Posicionar em zonas de sombra - Boyalı akrilik iplik kumaşlarda renk değişiklikleri standart ve doğal kabul edilir. Gölge alanlara yerleştiriniz - Изменения цвета следует считать нормой, они являются естественными в случае акриловых тканей с окрашенными волокнами. Размещать в тени

* Trattamento laminato su richiesta con quantità minima - Laminated finish available on request with a minimum quantity - Traitement laminé sur demande avec une quantité minimum - Laminierte Ausrüstung auf Anfrage mit einer Mindestmenge - Tratamiento laminado bajo pedido con una cantidad mínima - Tratamento laminado sob encomenda com quantidade mínima - Talep üzerine minimum miktarda lamine işlem - Ламинированная обработка по запросу с минимальным количеством

FOLIO

fiberglass polypropylene

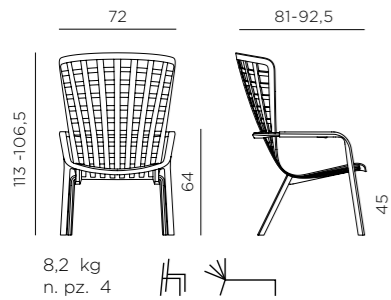

KIT FOLIO ROCKING

fiberglass polypropylene

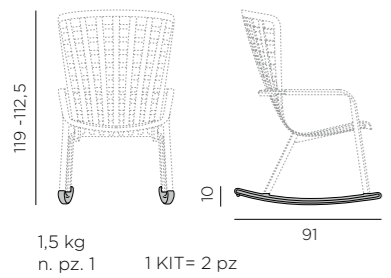

POGGIO

fiberglass polypropylene

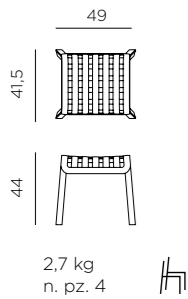

TIBERINA ARMCHAIR

new

regenerated fiberglass polypropylene
fiberglass polypropylene

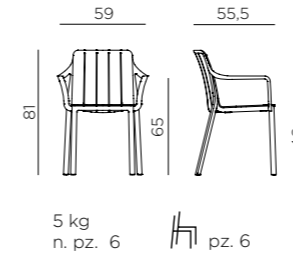

TIBERINA BISTROT

new

regenerated fiberglass polypropylene
fiberglass polypropylene

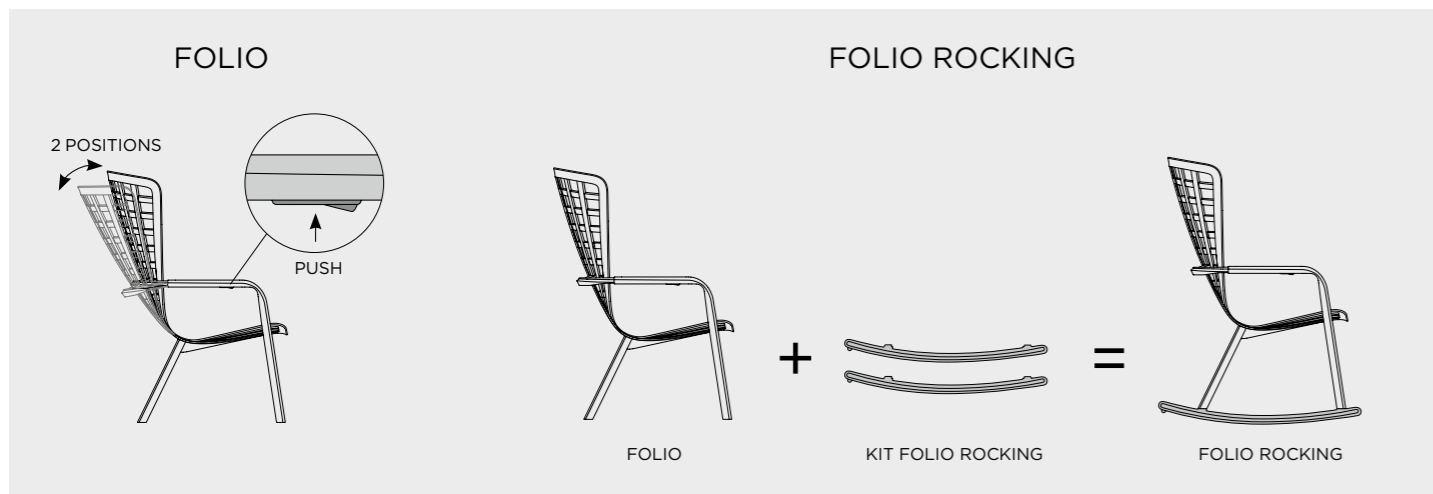
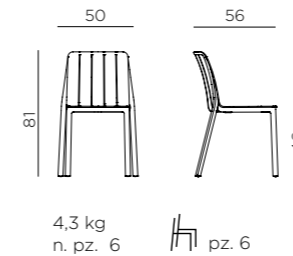

Il polipropilene fiberglass rigenerato può presentare delle variazioni di colore dovute all'utilizzo di materiale riciclato - Regenerated fiberglass polypropylene may vary in color due to the use of recycled material - Polypropylène fiberglass régénéré peut présenter variations de couleur en raison de l'utilisation de matériaux recyclés - Regeneriertem fiberglass-Polypropylen kann aufgrund der Verwendung von recyceltem Material Farbunterschiede aufweisen - El polipropileno fiberglass regenerado puede presentar variaciones de color debido al uso de material reciclado - O polipropileno fiberglass regenerado pode apresentar variações de cor devido ao uso de material reciclado - Rejenere edilmis polipropilen fiberglass, geri dönüşüm malzemesi kullanımı nedeniyle renk değişikliklerine maruz kalabilir - цвет регенерированного полипропиленового стекловолокна может иметь отличия вследствие использования переработанного материала

DOGA RELAX

fiberglass polypropylene

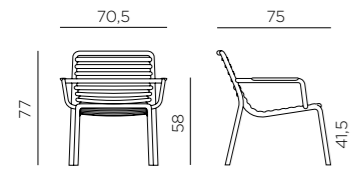

6 kg
n. pz. 4



BIANCO 40256.00.000 ANTRACITE 40256.02.000 CAPPUCCINO 40256.14.000 MENTA 40256.15.000 AGAVE 40256.16.000 PERA 40256.18.000



MARSALA 40256.21.000 TABACCO 40256.53.000

DOGA ARMCHAIR

fiberglass polypropylene

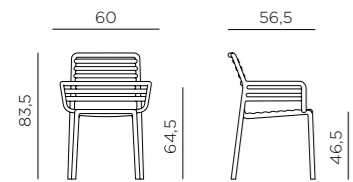

5,1 kg
n. pz. 6



BIANCO 40254.00.000 ANTRACITE 40254.02.000 CAPPUCCINO 40254.14.000 MENTA 40254.15.000 AGAVE 40254.16.000 PERA 40254.18.000



MARSALA 40254.21.000 TABACCO 40254.53.000

DOGA BISTROT

fiberglass polypropylene

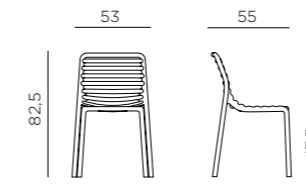

4,1 kg
n. pz. 6



BIANCO 40255.00.000 ANTRACITE 40255.02.000 CAPPUCCINO 40255.14.000 MENTA 40255.15.000 AGAVE 40255.16.000 PERA 40255.18.000



MARSALA 40255.21.000 TABACCO 40255.53.000

DOGA STOOL

fiberglass polypropylene

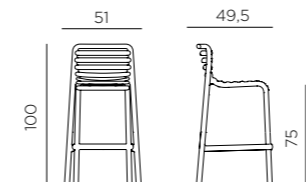

5,1 kg
n. pz. 4



BIANCO 40348.00.000 ANTRACITE 40348.02.000 CAPPUCCINO 40348.14.000 MENTA 40348.15.000 AGAVE 40348.16.000 PERA 40348.18.000



MARSALA 40348.21.000 TABACCO 40348.53.000

NET LOUNGE

fiberglass polypropylene

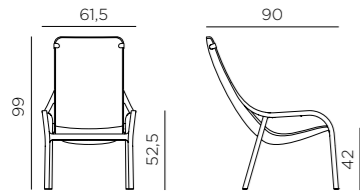

5,3 kg
n. pz. 4



BIANCO 40329.00.000 ANTRACITE 40329.02.000 SALICE 40329.04.000 TORTORA 40329.10.000 SENAPE 40329.56.000 CORALLO 40329.75.000

NET BENCH

fiberglass polypropylene

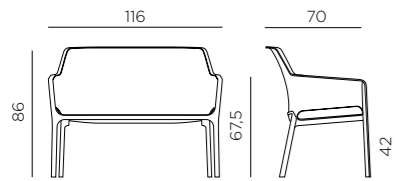

8,9 kg
n. pz. 20



BIANCO 40338.00.000 ANTRACITE 40338.02.000 SALICE 40338.04.000 TORTORA 40338.10.000 SENAPE 40338.56.000 CORALLO 40338.75.000

NET RELAX

fiberglass polypropylene

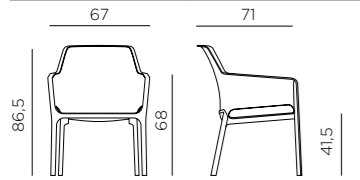

4,9 kg
n. pz. 20 pz. 6



BIANCO 40327.00.000 ANTRACITE 40327.02.000 SALICE 40327.04.000 TORTORA 40327.10.000 SENAPE 40327.56.000 CORALLO 40327.75.000

NET

fiberglass polypropylene

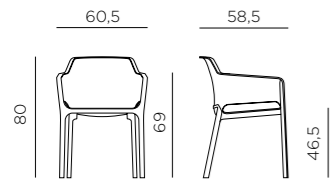

3,9 kg
n. pz. 6 pz. 6



BIANCO 40326.00.000.06 ANTRACITE 40326.02.000.06 SALICE 40326.04.000.06 TORTORA 40326.10.000.06 SENAPE 40326.56.000.06 CORALLO 40326.75.000.06

BIT

fiberglass polypropylene

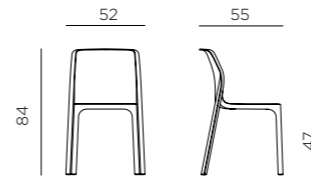

3,5 kg
n. pz. 6



BIANCO 40328.00.000.06 ANTRACITE 40328.02.000.06 SALICE 40328.04.000.06 TORTORA 40328.10.000.06 SENAPE 40328.56.000.06 CORALLO 40328.75.000.06

NET STOOL

fiberglass polypropylene

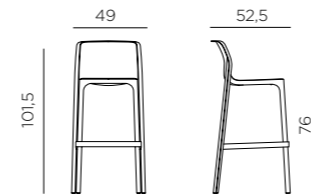

4,4 kg
n. pz. 4



BIANCO 40355.00.000 ANTRACITE 40355.02.000 SALICE 40355.04.000 TORTORA 40355.10.000 SENAPE 40355.56.000 CORALLO 40355.75.000

NET STOOL MINI

fiberglass polypropylene

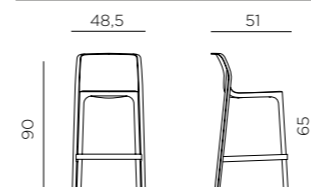

4,2 kg
n. pz. 4



BIANCO 40356.00.000 ANTRACITE 40356.02.000 SALICE 40356.04.000 TORTORA 40356.10.000 SENAPE 40356.56.000 CORALLO 40356.75.000

TRILL ARMCHAIR



fiberglass polypropylene

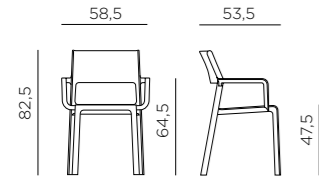

4,7 kg
n. pz. 6



BIANCO 40250.00.000 ANTRACITE 40250.02.000 GRIGIO 40250.03.000 ROSABOUQUET 40250.08.000 TORTORA 40250.10.000 AGAVE 40250.16.000



OTTANIO 40250.49.000 TABACCO 40250.53.000 SENAPE 40250.56.000

TRILL BISTROT

fiberglass polypropylene

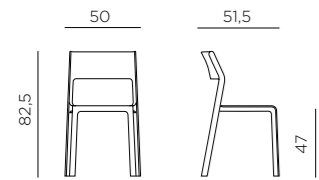

3,8 kg
n. pz. 6



BIANCO 40253.00.000 ANTRACITE 40253.02.000 GRIGIO 40253.03.000 ROSABOUQUET 40253.08.000 TORTORA 40253.10.000 AGAVE 40253.16.000



OTTANIO 40253.49.000 TABACCO 40253.53.000 SENAPE 40253.56.000

TRILL STOOL

fiberglass polypropylene

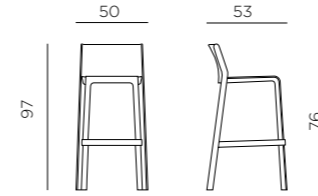

5 kg
n. pz. 4



BIANCO 40350.00.000 ANTRACITE 40350.02.000 GRIGIO 40350.03.000 ROSABOUQUET 40350.08.000 TORTORA 40350.10.000 AGAVE 40350.16.000



OTTANIO 40350.49.000 TABACCO 40350.53.000 SENAPE 40350.56.000

TRILL STOOL MINI

fiberglass polypropylene

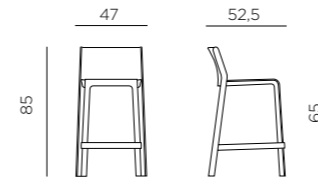

4,6 kg
n. pz. 4



BIANCO 40353.00.000 ANTRACITE 40353.02.000 GRIGIO 40353.03.000 ROSABOUQUET 40353.08.000 TORTORA 40353.10.000 AGAVE 40353.16.000



OTTANIO 40353.49.000 TABACCO 40353.53.000 SENAPE 40353.56.000

RIO BENCH ALU

aluminium

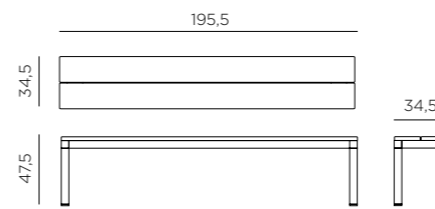

17 kg
n. pz. 1

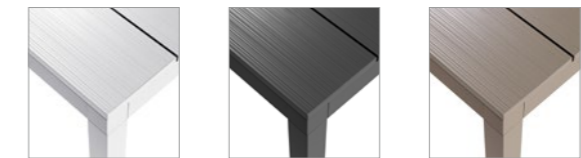

verniciato bianco 49053.00.000 verniciato antracite 49052.02.000 verniciato tortora 49059.10.000



Life Cycle Assessment
For more information visit: www.nardioutdoor.com/sustainability

EPD® dichiarazione ambientale di prodotto/ environmental product declaration

ATLANTICO

fiberglass polypropylene / synthetic fabric

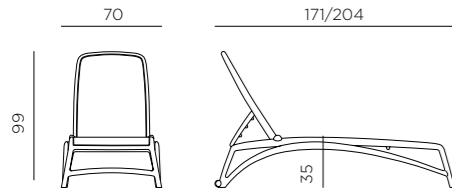

16 kg
n. pz. 20

Tessuto ricambiabile
Replaceable fabric
Tissu changeable
Auswechselbarer Stoff
Tela sostituibile
Tecidos recambiáveis
Değiştirilebilen Kumaş
Съемная ткань

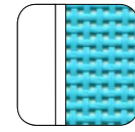

BIANCO
celeste
40450.00.075

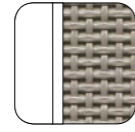

BIANCO
tortora
40450.00.104

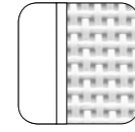

BIANCO
bianco
40450.00.107

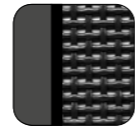

ANTRACITE
antracite
40450.02.057



ANTRACITE
celeste
40450.02.075

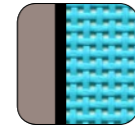

TORTORA
celeste
40450.10.075

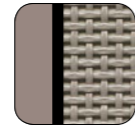

TORTORA
tortora
40450.10.104

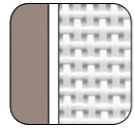

TORTORA
bianco
40450.10.107

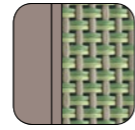

TORTORA
agave
40450.10.101

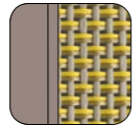

TORTORA
deserto
40450.10.103

BRACCIOLO ATLANTICO

fiberglass polypropylene

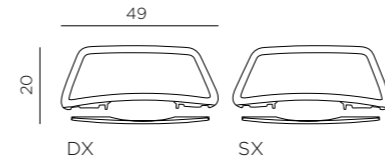

1,1 kg
n. pz. 1 1 KIT = 2 pz (1DX+1SX)

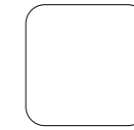

BIANCO
40452.00.000



ANTRACITE
40452.02.000



TORTORA
40452.10.000

RICAMBIO ATLANTICO

acetalic resin / synthetic fabric

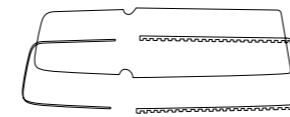

1,3 kg
n. pz. 1

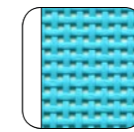

celeste
40460.00.075

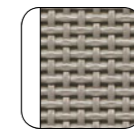

tortora
40460.00.104

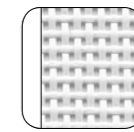

bianco
40460.00.107

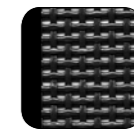

antracite
40460.01.057

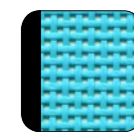

celeste
40460.01.075



tortora
40460.01.104

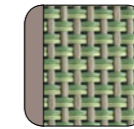

agave
40460.10.101

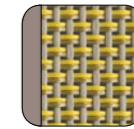

deserto
40460.10.103

TEVERE

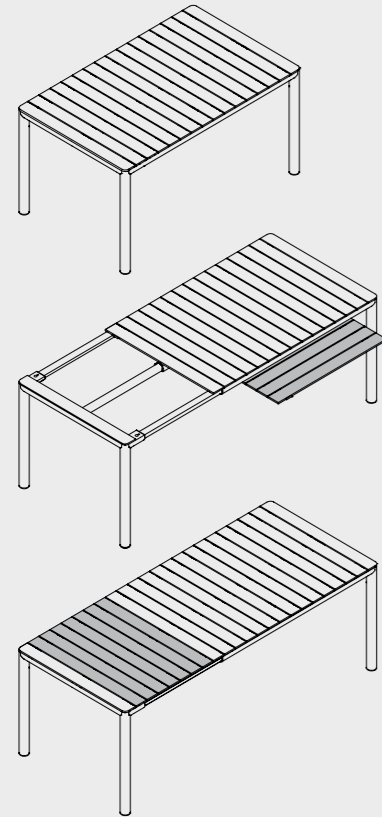

tevere 147 extensible
6/8 🧑 147/211x90x76,5 cm

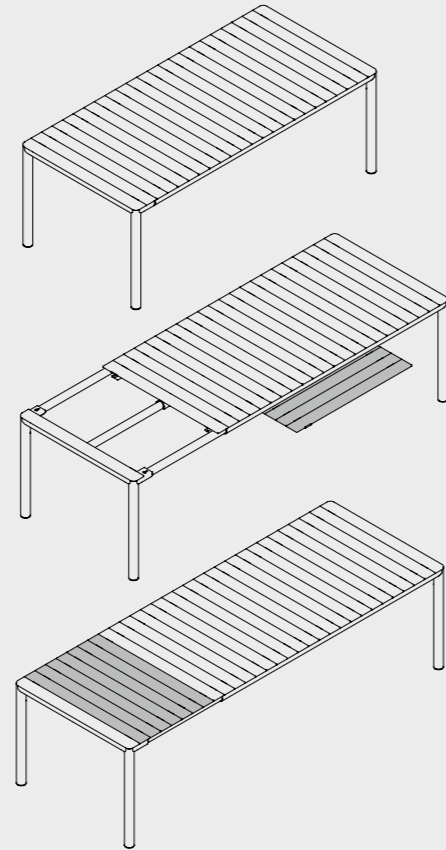

tevere 210 extensible
8/10 🧑 211/275x100x76,5 cm

TEVERE 210 EXTENSIBLE 8/10 🧑

regenerated fiberglass polypropylene / aluminium
fiberglass polypropylene / aluminium

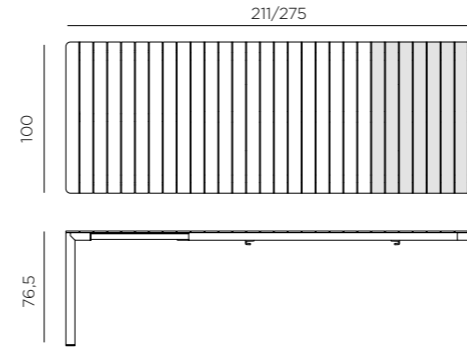

53 kg
n. pz. 1

regenerated



TERRA *
verniciato terra
49668.44.000



ANTRACITE *
verniciato antracite
49652.02.000



TORTORA
verniciato tortora
49659.10.000



CORDA
verniciato corda
49669.24.000

TEVERE 147 EXTENSIBLE 6/8 🧑 **new**

regenerated fiberglass polypropylene / aluminium
fiberglass polypropylene / aluminium

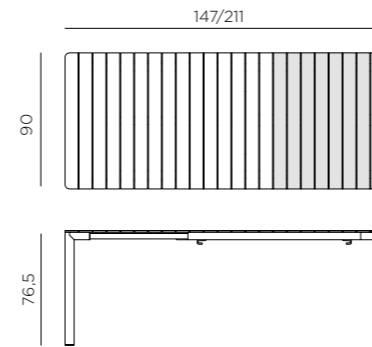

38 kg
n. pz. 1

regenerated



TERRA *
verniciato terra
49468.44.000



ANTRACITE *
verniciato antracite
49452.02.000



TORTORA
verniciato tortora
49459.10.000



CORDA
verniciato corda
49469.24.000

* Posizionare in zone d'ombra - Position in shaded areas - Placer dans des zones ombragées - In schattigen Bereichen aufstellen - Colocar en zonas de sombra - Posicionar em zonas de sombra - Gölgele alanlara yerleştiriniz - Размещать в тени

Il polipropilene fiberglass rigenerato può presentare delle variazioni di colore dovute all'utilizzo di materiale riciclato - Regenerated fiberglass polypropylene may vary in color due to the use of recycled material - Polypropylène fiberglass régénéré peut présenter variations de couleur en raison de l'utilisation de matériaux recyclés - Regeneriertem fiberglass-Polypropylen kann aufgrund der Verwendung von recyceltem Material Farbunterschiede aufweisen - El polipropileno fiberglass regenerado puede presentar variaciones de color debido al uso de material reciclado - O polipropileno fiberglass regenerado pode apresentar variações de cor devido ao uso de material reciclado - Rejenere edilmiş polipropilen fiberglass, geri dönüşüm malzemesi kullanımı nedeniyle renk değişikliklerine maruz kalabilir - цвет регенерированного полипропиленового стекловолокна может иметь отличия вследствие использования переработанного материала

RIO

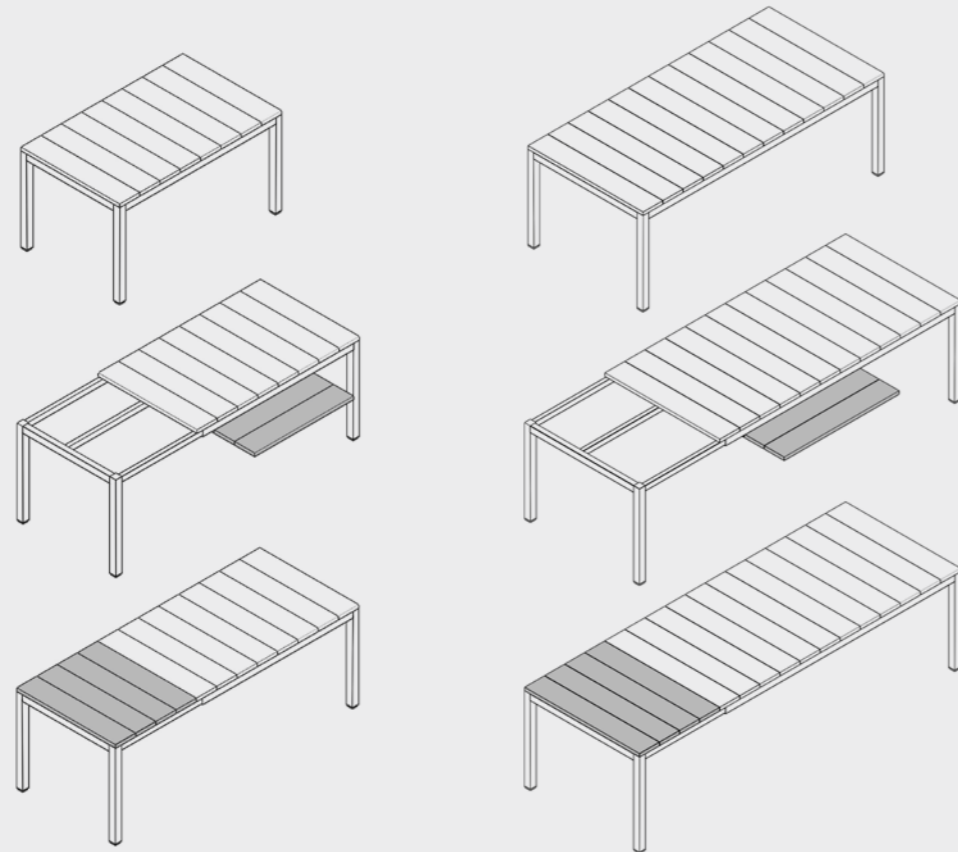

rio 140 extensible
6/8 140/210x85x76 cm

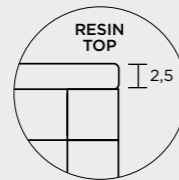

rio 210 extensible
8/10 210/280x100x76 cm

rio **ALU** 140 extensible
6/8 140/210x85x75 cm

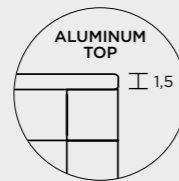

rio **ALU** 210 extensible
8/10 210/280x100x75 cm

RIO **ALU** 210 EXTENSIBLE 8/10

aluminium

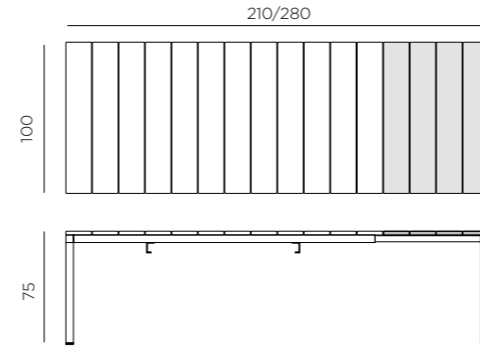

54 kg
n. pz. 1

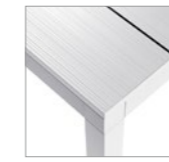

verniciato bianco
48853.00.000

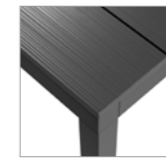

verniciato antracite
48852.02.000



verniciato tortora
48859.10.000

RIO **ALU** 140 EXTENSIBLE 6/8

aluminium

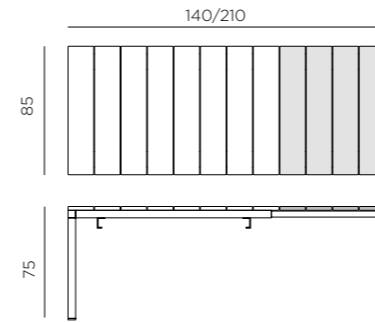

37,1 kg
n. pz. 1

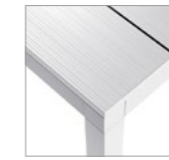

verniciato bianco
48653.00.000

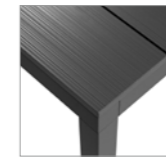

verniciato antracite
48652.02.000



verniciato tortora
48659.10.000

RIO **ALU** 210 FIX 8

aluminium

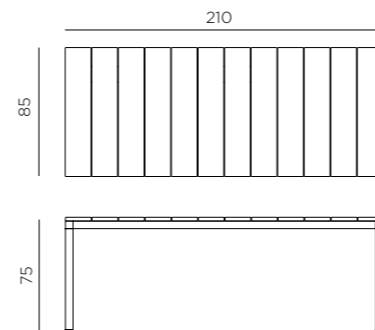

37 kg
n. pz. 1

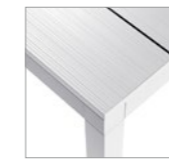

verniciato bianco
49153.00.000

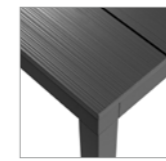

verniciato antracite
49152.02.000



verniciato tortora
49159.10.000

RIO 210 EXTENSIBLE 8/10

durelTOP / polypropylene / aluminium

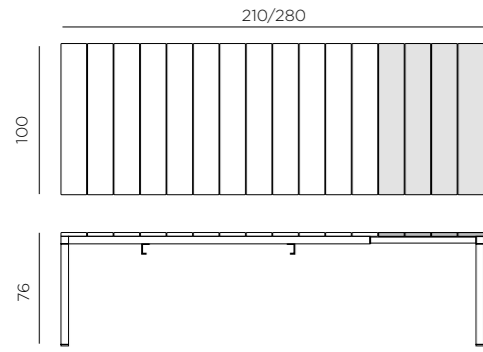

49 kg
n. pz. 1



BIANCO
verniciato bianco
48253.00.000

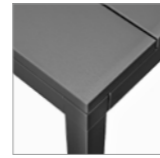

ANTRACITE *
verniciato antracite
48252.02.000

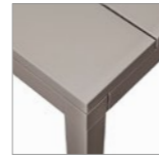

TORTORA
verniciato tortora
48259.10.000

CUBE 120X70

durelTOP / polypropylene / aluminium

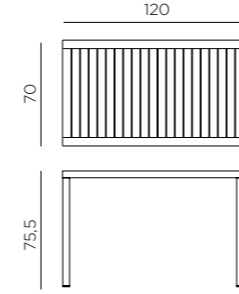

13,5 kg
n. pz. 1



BIANCO
verniciato bianco
47653.00.000



ANTRACITE *
verniciato antracite
47652.02.000



TORTORA
verniciato tortora
47659.10.000



TABACCO *
verniciato tabacco
47667.53.000

RIO 140 EXTENSIBLE 6/8

durelTOP / polypropylene / aluminium

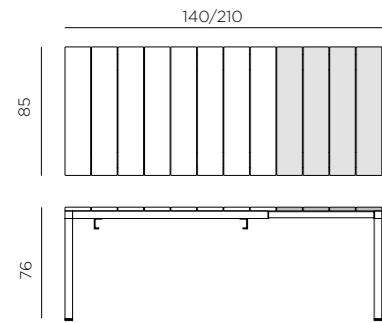

32,6 kg
n. pz. 1



BIANCO
verniciato bianco
48353.00.000

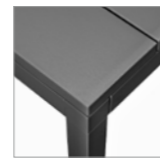

ANTRACITE *
verniciato antracite
48352.02.000



TORTORA
verniciato tortora
48359.10.000

CUBE 80

durelTOP / polypropylene / aluminium

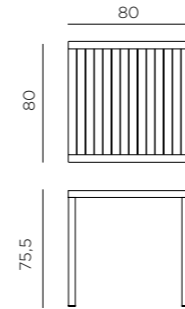

11,5 kg
n. pz. 1



BIANCO
verniciato bianco
48053.00.000



ANTRACITE
verniciato antracite
48052.02.000



TORTORA
verniciato tortora
48059.10.000



TABACCO
verniciato tabacco
48067.53.000

CUBE 140X80

durelTOP / polypropylene / aluminium

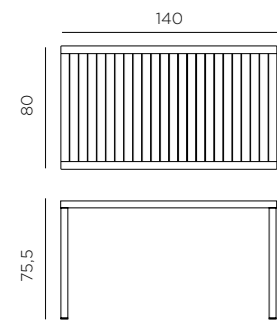

16,9 kg
n. pz. 1



BIANCO
verniciato bianco
47753.00.000



ANTRACITE *
verniciato antracite
47752.02.000



TORTORA
verniciato tortora
47759.10.000



TABACCO *
verniciato tabacco
47767.53.000

CUBE 70

durelTOP / polypropylene / aluminium

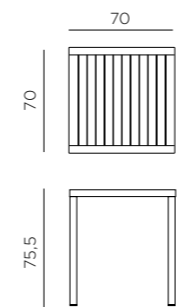

9,5 kg
n. pz. 1



BIANCO
verniciato bianco
47853.00.000



ANTRACITE
verniciato antracite
47852.02.000



TORTORA
verniciato tortora
47859.10.000



TABACCO
verniciato tabacco
47867.53.000

* Posizionare in zone d'ombra - Position in shaded areas - Placer dans des zones ombragées - In schattigen Bereichen aufstellen - Colocar en zonas de sombra - Posicionar em zonas de sombra - Gölgeyi alanlara yerleştiriniz - Размещать в тени

DOGA TABLE

fiberglass polypropylene

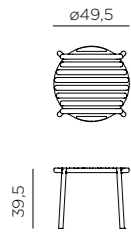

2,9 kg
n. pz. 4



BIANCO
40042.00.000



ANTRACITE
40042.02.000



CAPPUCCINO
40042.14.000



MENTA
40042.15.000



AGAVE
40042.16.000



PERA
40042.18.000



MARSALA
40042.21.000



TABACCO
40042.53.000

NET TABLE 100

fiberglass polypropylene

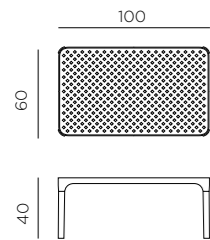

6,3 kg
n. pz. 1



BIANCO
40064.00.000



ANTRACITE
40064.02.000



SALICE
40064.04.000



TORTORA
40064.10.000



SENAPE
40064.56.000



CORALLO
40064.75.000

SPRITZ

fiberglass polypropylene

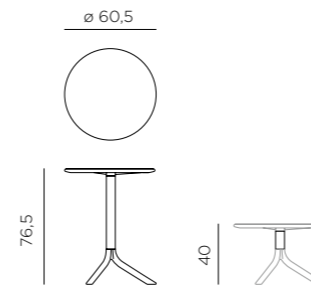

4,3 kg
n. pz. 1



BIANCO
40058.00.000



ANTRACITE
40058.02.000



ROSSO
40058.07.000



TORTORA
40058.10.000



AGAVE
40058.16.000



CELESTE
40058.39.000

POP

fiberglass polypropylene

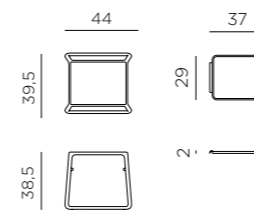

2,5 kg
n. pz. 4



BIANCO
40048.00.000



ANTRACITE
40048.02.000



TORTORA
40048.10.000

SIPARIO 3

regenerated fiberglass polypropylene

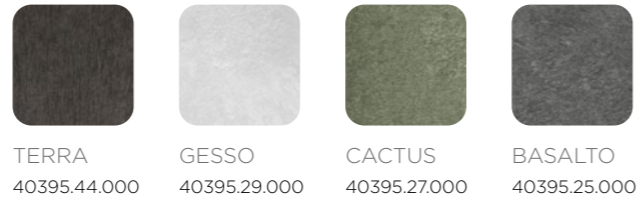
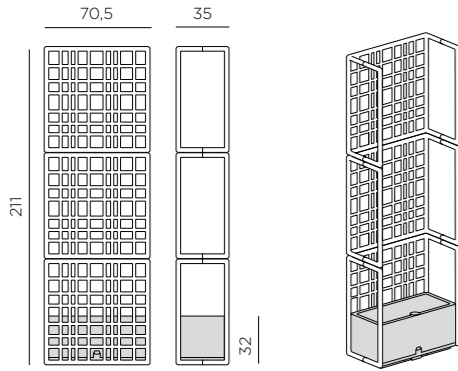

19,1 kg
n. pz. 1

SIPARIO 2



regenerated fiberglass polypropylene

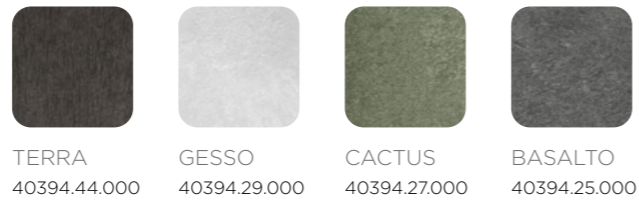
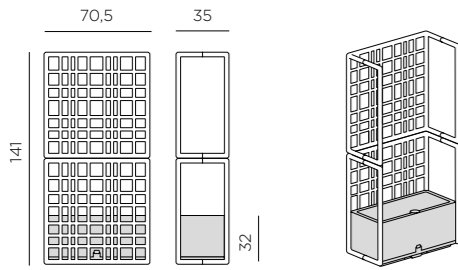

14,6 kg
n. pz. 1

SIPARIO MODULO

regenerated fiberglass polypropylene

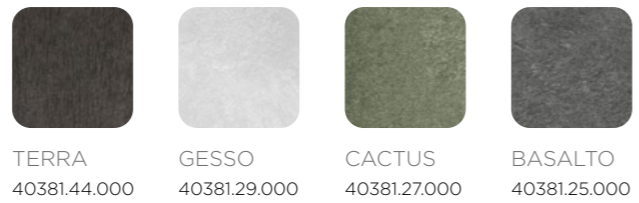
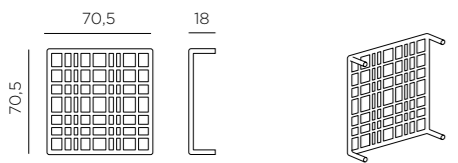

3,3 kg
n. pz. 1

SIPARIO VASO

regenerated fiberglass polypropylene

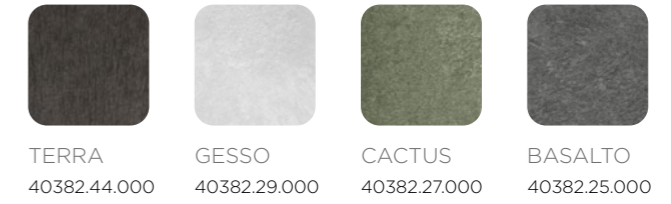
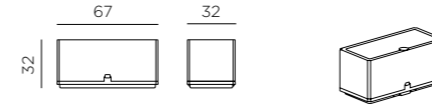

6,4 kg
n. pz. 1

SIPARIO CHIUSURA

regenerated fiberglass polypropylene

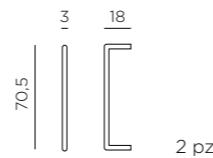

1 kg
n. pz. 1 1 KIT = 2 pz

SIPARIO KIT CLIPS

regenerated fiberglass polypropylene

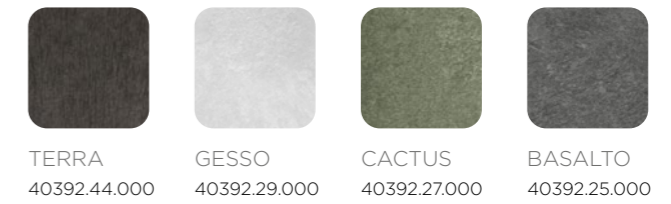
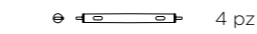

0,4 kg
n. pz. 1 1 KIT = 4+6 pz



Life Cycle Assessment

For more information visit: www.nardioutdoor.com/sustainability

Il polipropilene fiberglass rigenerato può presentare delle variazioni di colore dovute all'utilizzo di materiale riciclato - Regenerated fiberglass polypropylene may vary in color due to the use of recycled material - Polypropylène fiberglass régénéré peut présenter variations de couleur en raison de l'utilisation de matériaux recyclés - Regeneriertem fiberglass-Polypropylen kann aufgrund der Verwendung von recyceltem Material Farbunterschiede aufweisen - El polipropileno fiberglass regenerado puede presentar variaciones de color debido al uso de material reciclado - O polipropileno fiberglass regenerado pode apresentar variações de cor devido ao uso de material reciclado - Rejenere edilmiş polipropilen fiberglass, geri dönüşüm malzemesi kullanımı nedeniyle renk değişikliklerine maruz kalabilir - цвет регенерированного полипропиленового стекловолокна может иметь отличия вследствие использования переработанного материала

ACCESSORIES

CUSCINO DOGA RELAX

fabric

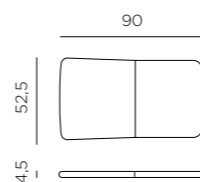

0,7 kg
n. pz. 4



lino
36256.00.152



avocado
Sunbrella®
36256.00.139



fumo
Sunbrella®
36256.00.193

new



rosa
Sunbrella®
36256.00.222

new

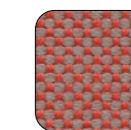

mattone
36256.00.221

CUSCINO DOGA ARMCHAIR

fabric



0,3 kg
n. pz. 4



lino
36254.00.152



avocado
Sunbrella®
36254.00.139



fumo
Sunbrella®
36254.00.193

new



rosa
Sunbrella®
36254.00.222

new

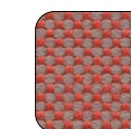

mattone
36254.00.221

CUSCINO DOGA BISTROT

fabric

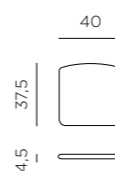

0,3 kg
n. pz. 4



lino
36255.00.152



avocado
Sunbrella®
36255.00.139



fumo
Sunbrella®
36255.00.193

new



rosa
Sunbrella®
36255.00.222

new

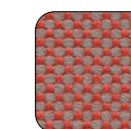

mattone
36255.00.221

CUSCINO TRILL

fabric

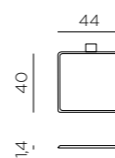

0,2 kg
n. pz. 4



grafite
36253.00.130

Solo per sedia Trill Bistrot - Only for Trill Bistrot chair -
Seulement pour la chaise Trill Bistrot - Nur für Trill Bistrot
Stuhl - Sólo para silla Trill Bistrot - Apenas para cadeira
Trill Bistrot - Sadece Trill Bistrot sandalyesi için - Только для
кресла Trill Bistrot.

CUSCINO NET BENCH

fabric

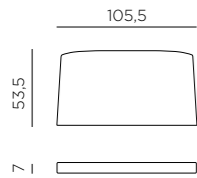

1,5 kg
n. pz. 4

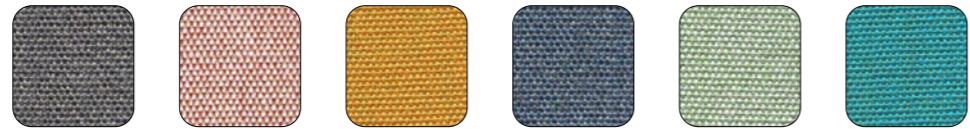

grey stone # 36338.00.064 rosa quarzo # 36338.00.066 senape # 36338.00.069 denim # 36338.00.070 the verde # 36338.00.071 sardinia # 36338.00.072

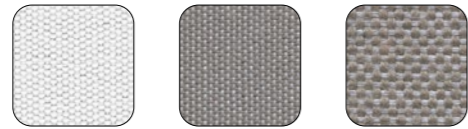

bianco 36338.00.155 grigio # 36338.00.163 grigio Sunbrella® * 36338.00.136

CUSCINO NET RELAX

fabric

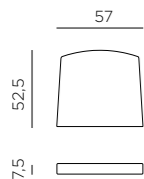

0,8 kg
n. pz. 4

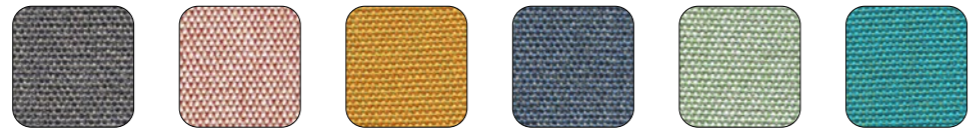

grey stone # 36327.00.064 rosa quarzo # 36327.00.066 senape # 36327.00.069 denim # 36327.00.070 the verde # 36327.00.071 sardinia # 36327.00.072



bianco 36327.00.155 grigio # 36327.00.163 grigio Sunbrella® * 36327.00.136

CUSCINO NET

fabric

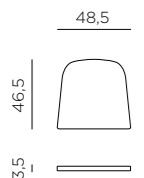

0,3 kg
n. pz. 4

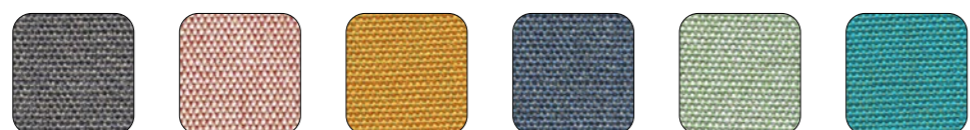

grey stone # 36326.00.064 rosa quarzo # 36326.00.066 senape # 36326.00.069 denim # 36326.00.070 the verde # 36326.00.071 sardinia # 36326.00.072



bianco 36326.00.155 grigio # 36326.00.163 grigio Sunbrella® * 36326.00.136

CUSCINO SHELL (NET RELAX)

fabric

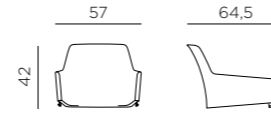

2,2 kg
n. pz. 2



rosa quarzo # 36327.01.066 denim # 36327.01.070 grigio # 36327.01.163

Utilizzabile solo con cuscino Net Relax - Can only be used with Net Relax cushion - À utiliser uniquement avec le coussin Net Relax - Kann nur mit Net Relax Kissen verwendet werden - Se puede utilizar sólo con el cojín Net Relax - Só pode ser usada em conjunto com almofada de assento Net Relax - Sadece Net Relax minderiyle kullanılmali - Можно использовать только с подушкой Net Relax.

CUSCINO BIT

fabric

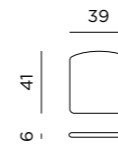

0,3 kg
n. pz. 4



grigio # 36328.00.163

CUSCINO POGGIATESTA NET LOUNGE

fabric

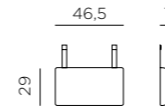

0,3 kg
n. pz. 4



rosa quarzo # 36329.04.066 senape # 36329.04.069 grigio Sunbrella® 36329.04.136

TELO MARE NET LOUNGE

fabric



0,4 kg
n. pz. 12

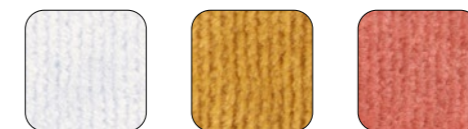

bianco 149329.60.050 senape 149329.65.650 corallo 149329.67.550

Variazioni di colore sono da ritenersi standard e naturali nei tessuti acrilici tinto filo. Posizionare in zone d'ombra - Colour variations are to be considered standard and natural in yarn-dyed acrylic fabrics. Position in shaded areas - Les variations de couleur des tissus acryliques au fil teint sont standard et naturelles. Placer dans des zones ombragées - Farbveränderungen sind als Standard und in im Garn gefärbten Acrylgeweben als natürlich zu betrachten. In schattigen Bereichen aufstellen - Las variaciones de color son normales y naturales en las telas acrílicas teñidas en hilo. Colocar en zonas de sombra - As variações de cor são consideradas standard e naturais nos tecidos acrílico tingidos com fio. Posicionar em zonas de sombra - Boyalı akrilik iplik kumaşlarda renk değişiklikleri standart ve doğal kabul edilir. Gölgeli alanlara yerleştiriniz - Изменения цвета следует считать нормой, они являются естественными в случае акриловых тканей с окрашенными волокнами. Размещать в тени

* Trattamento laminato su richiesta con quantità minima - Laminated finish available on request with a minimum quantity - Traitement laminé sur demande avec une quantité minimum - Laminierte Ausrüstung auf Anfrage mit einer Mindestmenge - Tratamiento laminado bajo pedido con una cantidad mínima - Tratamento laminado sob encomenda com quantidade mínima - Talep üzerine minimum miktarda lamine işlem - Ламинированная обработка по запросу с минимальным количеством

CUSCINO FOLIO COMFORT

fabric

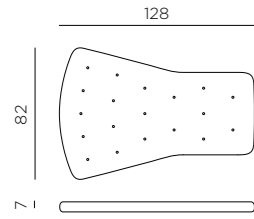

1,4 kg
n. pz. 1



CUSCINO POGGIATESTA FOLIO

fabric

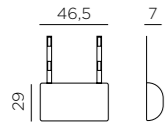

0,3 kg
n. pz. 4



CUSCINO PASSEPARTOUT

fabric

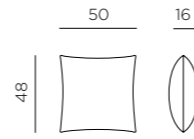

0,7 kg
n. pz. 4



CUSCINO RETTANGOLARE

fabric

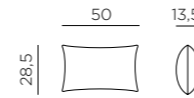

0,6 kg
n. pz. 4

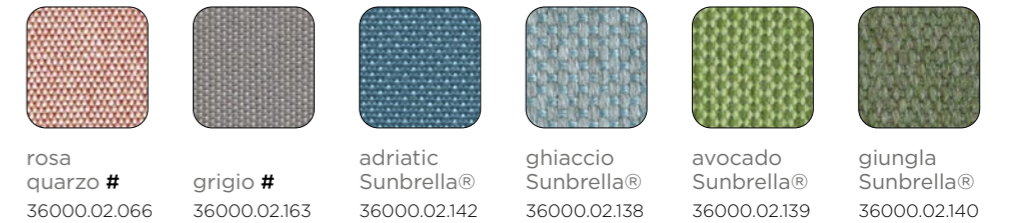

Variazioni di colore sono da ritenersi standard e naturali nei tessuti acrilici tinto filo. Posizionare in zone d'ombra - Colour variations are to be considered standard and natural in yarn-dyed acrylic fabrics. Position in shaded areas - Les variations de couleur des tissus acryliques au fil teint sont standard et naturelles. Placer dans des zones ombragées - Farbveränderungen sind als Standard und in im Garn gefärbten Acrylgeweben als natürlich zu betrachten. In schattigen Bereichen aufstellen - Las variaciones de color son normales y naturales en las telas acrílicas teñidas en hilo. Colocar en zonas de sombra - As variações de cor são consideradas standard e naturais nos tecidos acrílico tingidos com fio. Posicionar em zonas de sombra - Boyalı akrilik iplik kumaşlarda renk değişiklikleri standart ve doğal kabul edilir. Gölge alanlara yerleştiriniz - Изменения цвета следует считать нормой, они являются естественными в случае акриловых тканей с окрашенными волокнами. Размещать в тени

COVER SMALL

(4/6 CHAIRS / 1 ELEMENT SOFA)

fabric

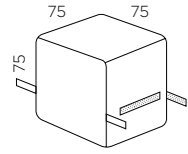

0,7 kg
n. pz. 25



smoke
37000.01.204

COVER MEDIUM

(2/4 SUNLOUNGERS)

fabric

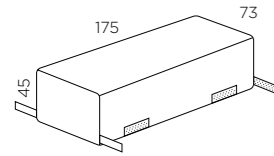

0,8 kg
n. pz. 20



smoke
37000.02.204

COVER LARGE

(2 ELEMENT SOFA / TABLE 140)

fabric

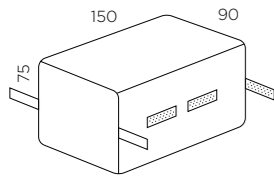

1,1 kg
n. pz. 20



smoke
37000.03.204

COVER EXTRALARGE

(3 ELEMENT SOFA / TABLE 210)

fabric

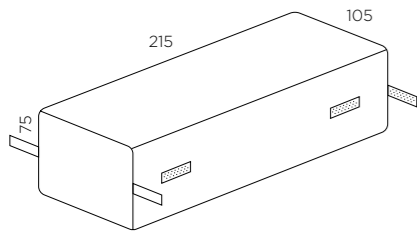

1,6 kg
n. pz. 15



smoke
37000.04.204

MATERIALS

polypropylene

Polipropilene trattato anti-UV e colorato in massa. Riciclabile al 100% - Polypropylene with UV additives and is uniformly colored. 100% Recyclable resin - Polypropylène traité anti-UV et coloré dans la masse. Résine recyclable 100% - UV-beständigem Polypropylen, voll durchgefärbt. 100% Recyclebarer Kunststoff - Polipropileno tratado anti-UV y teñido en masa. Resina reciclable 100% - Polipropileno com tratamento anti-UV colorido na totalidade. Resina reciclável 100% - Işığa dayanıklı ve boyalı olarak granül çekilmiş %100 geri dönüşümlü polipropilen kompozit hammadde - Полипропилен с обработкой анти-УФ, окрашенное в массе. На 100% пригодно для вторичной переработки.

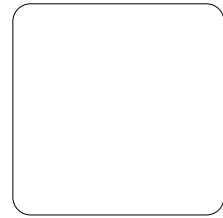

BIANCO .00



GRIGIO .03



ANTRACITE .02



CORDA .24



TORTORA .10



TABACCO .53



CELESTE .39



OTTANIO .49



SALICE .04



MENTA .15



AGAVE .16



PERA .18



CAPPUCCINO .14



SENAPE .56

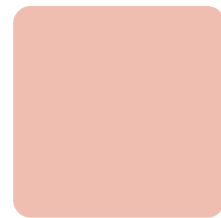

ROSA BOUQUET .08

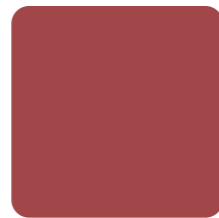

MARSALA .21



CORALLO .75



ROSSO .07

fiberglass polypropylene

Polipropilene fiberglass trattato anti-UV e colorato in massa. Resina riciclabile al 100% - Uniformly colored fiberglass polypropylene resins with UV additives. 100% Recyclable resin - Polypropylène fiberglass traité anti-UV et coloré dans la masse. Résine recyclable 100% - Uv-beständigem fiberglass Polypropylen, voll durchgefärbt. 100% Recyclebarer Kunststoff - Polipropileno fiberglass tratado anti-UV y teñido en masa. Resina reciclable 100% - Polipropileno fiberglass com tratamento anti-UV colorido na totalidade. Resina reciclável 100% - Işığa dayanıklı ve boyalı olarak granül çekilmiş %100 geri dönüşümlü cam elyaf katkılı polipropilen kompozit hammadde - Полипропилен фиброволокно с обработкой анти-УФ, окрашенное в массе. На 100% пригодно для вторичной переработки.

regenerated fiberglass polypropylene

Polipropilene fiberglass rigenerato trattato anti-UV e colorato in massa. Resina riciclabile al 100% - Regenerated uniformly colored fiberglass polypropylene resins with UV additives. 100% Recyclable resin - Polypropylène fiberglass régénérée traité anti-UV et coloré dans la masse. Résine recyclable 100% - Regeneriertem UV-beständigem fiberglass-Polypropylen, voll durchgefärbt. 100% Recyclebarer Kunststoff - Polipropileno fiberglass regenerado tratado

anti-UV y teñido en masa. Resina reciclable 100% - Polipropileno fiberglass regenerado com tratamento anti-UV colorido na totalidade. Resina reciclável 100% - Uv katlı maddeleriyle fiberglass polipropilen reçine ile renklendirilip düzgün bir şekilde tekrar oluşturulmuştur - Переработанный, крашеный, полипропилен fiberglass обработанный против проникновения ультрафиолетовых лучей. На 100% пригодно для вторичной переработки.



TERRA .44



GESSO .29

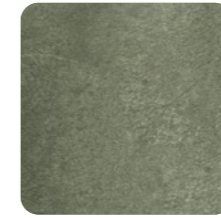

CACTUS .27

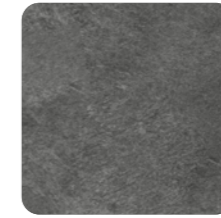

BASALTO .25

Il polipropilene fiberglass rigenerato può presentare delle variazioni di colore dovute all'utilizzo di materiale riciclato - Regenerated fiberglass polypropylene may vary in color due to the use of recycled material - Polypropylène fiberglass régénéré peut présenter variations de couleur en raison de l'utilisation de matériaux recyclés - Regeneriertem fiberglass-Polypropylen kann aufgrund der Verwendung von recyceltem Material Farbunterschiede aufweisen - El polipropileno fiberglass regenerado puede presentar

variaciones de color debido al uso de material reciclado - O polipropileno fiberglass regenerado pode apresentar variações de cor devido ao uso de material reciclado - Rejenere edilmiş polipropilen fiberglass, geri dönüşüm malzemesi kullanımı nedeniyle renk değişikliklerine maruz kalabilir - цвет регенерированного полипропиленового стекловолокна может иметь отличия вследствие использования переработанного материала

Sunbrella® acrylic fabric



100% fibra acrílica Sunbrella® tinto in massa. Trattamento idrorepellente, antimacchia, antimuffa. Solidità alla luce 8/8. Lavabile a 30° - 100% Sunbrella® acrylic fiber mass dyed. Water repellent treatment, dirt repellent and anti-mould treatment. 8/8 light fastness. Washable at 30° - 100% fibre acrylique Sunbrella® teintée en masse. Traitement imperméable, anti-taches et anti-moisissure. Résistance à la lumière 8/8. Lavable à 30° - 100% fasergefärbtes Sunbrella® Polyacryl. Wasserabweisend Ausrüstung, gegen Flecken und Schimmel ausgerüstet. Lichtechtheit 8/8. Waschbar bei 30° - 100% fibra acrílica

Sunbrella® tintada en masa. Tratamiento por la repelencia al agua, protección antimanchas, antimoho. Solidez a la luz 8/8. Lavable a 30° - 100% fibra acrílica Sunbrella® tingida em massa. Tratamento hidrorrepelente, antimancha e antimoho. Resistência à luz 8/8. Lavável a 30° - %100 akrilik elyaf Sunbrella® çözültü halinde boyanmış. Su itici, leke itici, küf önleyici ile muamele edilmiş. Işık haslığı 8/8. 30°de yıkanabilir - 100% akrilovoe volokno Sunbrella®, окрашенное в массе. Водоотталкивающая, пятноустойчивая и противогрибковая обработка. Светостойкость 8/8. Стирать при 30°.



grigio
Sunbrella® .136
275 gr/m²



canvas
Sunbrella® .141
275 gr/m²

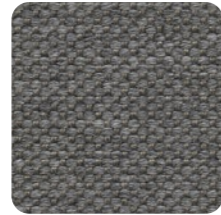

fumo
Sunbrella® .193
275 gr/m²

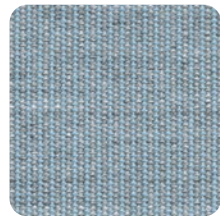

artic
Sunbrella® .223
260 gr/m²



ghiaccio
Sunbrella® .138
275 gr/m²



adriatic
Sunbrella® .142
260 gr/m²

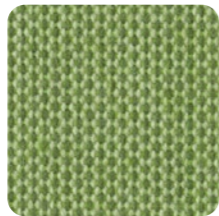

avocado
Sunbrella® .139
260 gr/m²



felce
Sunbrella® .224
260 gr/m²

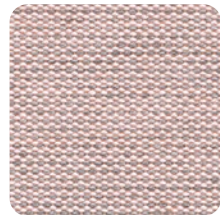

rosa
Sunbrella® .222
275 gr/m²

Sunbrella® EXTRA



Tessuti disponibili su ordinazione per minimi quantitativi d'ordine solo per il prodotto KOMODO - Fabrics available to order for minimum order quantities for the KOMODO product only - Tissus disponibles sur commande de quantités minimales pour le produit KOMODO uniquement - Gewebe auf Bestellung für Mindestbestellmengen nur für das Produkt KOMODO erhältlich

- Telas disponibles bajo pedido para cantidades mínimas solo para el producto KOMODO - Tecidos disponíveis por encomenda para quantidades mínimas de encomenda apenas para o produto KOMODO - Sadece KOMODO ürünü için minimum sipariş miktarına göre sipariş verilebilecek kumaşlar - ткани на заказ для минимального объема заказа только для изделия KOMODO.



marble
Sunbrella® .186
260 gr/m²



mink brown
Sunbrella® .183
260 gr/m²

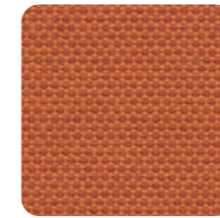

pumpkin
Sunbrella® .184
260 gr/m²

lamine treatment

(Su richiesta - On request - Sur demande - Auf Anfrage - Bajo pedido - Sob encomenda - İstek üzerine - По запросу)

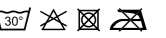

Il tessuto è accoppiato internamente con un film in poliuretano che lo rende impermeabile. La parte accoppiata in poliuretano non deve essere esposta al sole. Applicabile su richiesta con quantità minima su tessuti acrilici Sunbrella® - The fabric is bonded with a polyurethane film that makes it waterproof. The polyurethane laminated surface should not be exposed to direct sunlight. Applicabile on Sunbrella® acrylic fabrics on request with a minimum quantity - Le tissu est doublé en interne avec un film de polyuréthane qui le rend imperméable. La partie en polyuréthane ne doit pas être exposée au soleil. Applicabile sur demande avec une quantité minimale sur les tissus acryliques Sunbrella® - Das Gewebe ist innen mit einer Polyurethanfolie verbunden, die es wasserdicht macht. Das mit Polyurethan verbundene Teil darf nicht der Sonne ausgesetzt werden. Auf Anfrage mit Mindestmenge auf Sunbrella® Polyacryl Gewebe anwendbar - El tejido

está acoplado internamente con una película de poliuretano que lo hace impermeable. La parte acoplada de poliuretano no debe exponerse al sol. Aplicable bajo pedido con una cantidad mínima en tejidos acrílicos Sunbrella® - O tecido é dublado com filme interno de poliuretano que o torna impermeável. O lado que possui o filme de poliuretano não pode ser exposta ao sol. Aplicável sob encomenda, com quantidade mínima, em tecidos acrílicos Sunbrella® - Kumaş, su geçirmez hale getiren bir poliüretan film ile dahili olarak birleştirilmiştir. Birleştirilmiş poliüretan bölümler güneşe maruz bırakılmamalıdır. Sunbrella® akrilik kumaşlar üzerine minimum miktarda istek üzerine uygulanabilir - Ткань внутренне соединена с полиуретановой пленкой, которая делает ее водонепроницаемой. та часть, где имеется добавка полиуритана не выставлять на солнце. Применяется по запросу с минимальным количеством на акриловых тканях Sunbrella®.

recycled Sunbrella® acrylic fabric



50% fibra acrilica Sunbrella® riciclata tinto in massa, 47% fibra acrilica Sunbrella® tinto in massa, 3% poliester. Solidità alla luce 8/8, lavabile a 30°, trattamento Non PFAS idrorepellente, antimacchia. - 50% recycled Sunbrella® acrylic fiber mass dyed, 47% Sunbrella® acrylic fiber mass dyed, 3% polyester. 8/8 light fastness, washable at 30°, non-PFAS water-repellent, stain-proof treatment. - 50% fibre acrylique Sunbrella® recyclée teintée en masse, 47% fibre acrylique Sunbrella® teintée en masse, 3% de polyester. Résistance à la lumière 8/8, lavable à 30°, traitement imperméable sans PFAS et anti-taches. - 50% fasergefärbtes, recyceltes Sunbrella® Polyacryl, 47% fasergefärbtes Sunbrella® Polyacryl, 3% Polyester. Lichtechtheit 8/8, waschbar bei 30°, Wasser- und fleckabweisende Beschichtung ohne PFAS. - 50% fibra acrilica Sunbrella® reciclada tintada en masa, 47% fibra acrilica Sunbrella® tintada

en masa, 3% poliéster. Solidez a la luz 8/8, lavable a 30°, tratamiento sin PFAS, hidrorrepelente, antimancha. - 50% fibra acrilica Sunbrella® reciclada tingida em massa, 47% fibra acrilica Sunbrella® tingida em massa, 3% de poliéster. Resistência à luz 8/8, lavável a 30°, tratamento sem perfluorados (PFAS) hidrorrepelente, anti-mancha. - %50 geri dönüştürülmüş akrilik elyaf Sunbrella® çözelti halindeyken boyanmış, %47 akrilik elyaf Sunbrella® çözelti halindeyken boyanmış, % 3 polyester. Işığa dayanıklılık 8/8, 30°de yıkanabilir, PFAS içermeyen su geçirmez, leke tutmaz işlem. - 50% переработанное акриловое волокно Sunbrella®, окрашенное в массе, 47% акриловое волокно Sunbrella®, окрашенное в массе, 3% полиэстер. Светостойкость 8/8, стирка при 30°, водоотталкивающая обработка без ПФАС, грязеотталкивающая



perla
Sunbrella® .213
365 gr/m²



lava
Sunbrella® .215
365 gr/m²



cannella
Sunbrella® .219
365 gr/m²



timo
Sunbrella® .217
365 gr/m²



giungla
Sunbrella® .140
340 gr/m²

33% fibra acrilica Sunbrella® riciclata tinto in massa, 65% fibra acrilica Sunbrella® tinto in massa, 2% poliester. Solidità alla luce 8/8, lavabile a 30°, trattamento Non PFAS idrorepellente, antimacchia. - 33% recycled Sunbrella® acrylic fiber mass dyed, 65% Sunbrella® acrylic fiber mass dyed, 2% polyester. 8/8 light fastness, washable at 30°, non-PFAS water-repellent, stain-proof treatment. - 33% fibre acrylique Sunbrella® recyclée teintée en masse, 65% fibre acrylique Sunbrella® teintée en masse, 2% de polyester. - Résistance à la lumière 8/8, lavable à 30°, traitement imperméable sans PFAS et anti-tache. - 33% fasergefärbtes, recyceltes Sunbrella® Polyacryl, 65% fasergefärbtes Sunbrella® Polyacryl, 2% Polyester. Lichtechtheit 8/8, waschbar bei 30°, Wasser- und fleckabweisende Beschichtung ohne PFAS. - 33% fibra acrilica Sunbrella® reciclada tintada en masa, 65% fibra acrilica Sunbrella® tintada

en masa, 2% poliéster. Solidez a la luz 8/8, lavable a 30°, tratamiento sin PFAS, hidrorrepelente, antimancha. - 33% fibra acrilica Sunbrella® reciclada tingida em massa, 65% fibra acrilica Sunbrella® tingida em massa, 2% de poliéster. Resistência à luz 8/8, lavável a 30°, tratamento sem perfluorados (PFAS) hidrorrepelente, anti-mancha. - %33 geri dönüştürülmüş akrilik elyaf Sunbrella® çözelti halindeyken boyanmış, %65 akrilik elyaf Sunbrella® çözelti halindeyken boyanmış, % 2 polyester. Işığa dayanıklılık 8/8, 30°de yıkanabilir, PFAS içermeyen su geçirmez, leke tutmaz işlem. - 33% переработанное акриловое волокно Sunbrella®, окрашенное в массе, 65% акриловое волокно Sunbrella®, окрашенное в массе, 2% полиэстер. Светостойкость 8/8, стирка при 30°, водоотталкивающая обработка без ПФАС, грязеотталкивающая



perla arredo
Sunbrella® .214
365 gr/m²



lava arredo
Sunbrella® .216
365 gr/m²



cannella arredo
Sunbrella® .220
365 gr/m²



timo arredo
Sunbrella® .218
365 gr/m²

Il tessuto rigenerato Sunbrella può presentare delle variazioni di colore dovute all'utilizzo di materiale riciclato - The Sunbrella regenerated fabric may vary in color due to the use of recycled material - Le tissu régénéré Sunbrella peut présenter variations de couleur en raison de l'utilisation de matériaux recyclés - Das regenerierte Gewebe Sunbrella kann aufgrund der Verwendung von recyceltem Material Farbunterschiede aufweisen - El tejido regenerado Sunbrella puede presentar variaciones de color debido al uso de material reciclado - O tecido regenerado Sunbrella pode apresentar variações de cor devido ao uso de material reciclado - Sunbrella rejenere kumaş, geri dönüştürülmüş malzeme kullanımı nedeniyle renk farklılıkları gösterebilir - цвет регенерированной ткани Sunbrella может иметь отличия вследствие использования переработанного материала

acrylic fabric

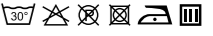

Fibra acrilica 100% tinto filo. Trattamento antimacchia, antimuffa. Solidità alla luce 5/8. Lavabile a 30° - 100% yarn dyed acrylic. Dirt repellent and anti-mould treatment. 5/8 light fastness. Washable at 30° - 100% fibre acrylique teintée en fils. Traitement anti-taches et anti-moisissure. Résistance à la lumière 5/8. Lavable à 30° - 100% garnggefärbtes Polyacryl Gewebe. Gegen Flecken und Schimmel Ausrüstung. Lichtechtheit 5/8. Waschbar bei 30° - 100% hilo teñido

acrílico. Protección antimanchas, antimoho. Solidez a la luz 5/8. Lavable a 30° - 100% fibra acrilica tingida com fio. Tratamento antimancha e antimoho. Resistência à luz 5/8. Lavável a 30° - %100 akrilik elyaf boyalı iplik. Leke itici, küf önleyici ile muamele edilmiş. Işık haslığı 5/8. 30°de yıkanabilir - Акриловое волокно 100% окрашенное в прже. Пятнустойчивая и противоплесневая обработка. Светостойкость 5/8. Стирать при 30°.

Variazioni di colore sono da ritenersi standard e naturali nei tessuti acrilici tinto filo. Posizionare in zone d'ombra - Colour variations are to be considered standard and natural in yarn-dyed acrylic fabrics. Position in shaded areas - Les variations de couleur des tissus acryliques au fil teint sont standard et naturelles. Placer dans des zones ombragées - Farbveränderungen sind als Standard und in im Garn gefärbten Acrylgeweben als natürlich zu betrachten. In schattigen Bereichen aufstellen - Las variaciones de color son normales y naturales en las telas acrílicas teñidas en hilo. Colocar en zonas de sombra - As variações de cor são consideradas standard e naturais nos tecidos acrílico tingidos com fio. Posicionar em zonas de sombra - Boyalı akrilik iplik kumaşlarda renk değişiklikleri standart ve doğal kabul edilir. Gölgeli alanlara yerleştiriniz - Изменения цвета следует считать нормой, они являются естественными в случае акриловых тканей с окрашенными волокнами. Размещать в тени.

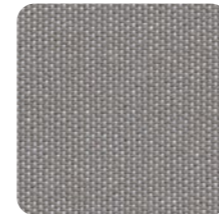

grigio .163
240 gr/m²



grey stone .064
240 gr/m²

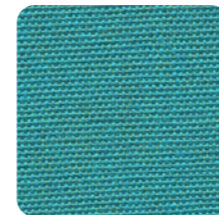

sardinia .072
240 gr/m²



denim .070
240 gr/m²

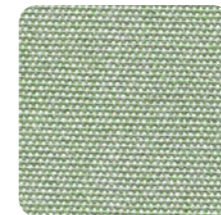

the verde .071
240 gr/m²



senape .069
240 gr/m²



rosa quarzo .066
240 gr/m²

acrylic fabric with digital print



Fibra acrilica 100% stampa digitale. Solidità alla luce 6. Lavabile a 30° - 100% acrylic fiber with digital print. 6 light fastness. Washable at 30° - 100% fibre acrylique impression numérique. Résistance à la lumière 6. Lavable à 30° - 100% Polyacrylfaser mit Digitaldruck. Lichtechtheit 6. Waschbar bei 30° - 100%

fibra acrilica impresión digital. Solidez a la luz 6. Lavable a 30° - 100% fibra acrilica estampa digital. Resistência à luz 6. Lavável a 30° - %100 dijital baskı akrilik elyaf. Işık haslığı 6. 30°de yıkanabilir - 100% акриловое волокно с цифровым рисунком, окрашенное в процессе производства. Светостойкость 6. Стирка при 30°.



tropical .081
190 gr/m²

mass dyed acrylic fabric

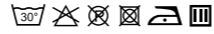

100% fibra acrilica tinto in massa. Trattamento idrorepellente, antimacchia, antimuffa. Solidità alla luce 7/8. Lavabile a 30° - 100% acrylic fiber mass dyed. Water repellent treatment, dirt repellent and anti-mould treatment. 7/8 light fastness. Washable at 30° - 100% fibre acrylique teintée en masse. Traitement imperméable, anti-taches et anti-moisissure. Résistance à la lumière 7/8. Lavable à 30° - 100% fasergefärbtes Polyacryl. Wasserabweisend Ausrüstung, gegen Flecken und Schimmel ausgerüstet. Lichtechtheit 7/8. Waschbar bei

30° - 100% fibra acrílica tintada en masa. Tratamiento hidropelente, protección antimanchas, antimoho. Solidez a la luz 7/8. Lavable a 30° - 100% fibra acrílica tingida em massa. Tratamento hidropelente, antimancha e antimoho. Resistência à luz 7/8. Lavável a 30° - %100 akrilik elyaf çözelti halindeyken boyanmış. Su itici, leke itici, küf önleyici ile muamele edilmiş. Işık haslıđı 7/8. 30°de yıkanabilir - 100% акриловое волокно окрашенное в массе. Водоотталкивающая, пятноустойчивая и противоплесневая обработка. Светостойкость 7/8. Стирать при 30°.



lino .152
280 gr/m²

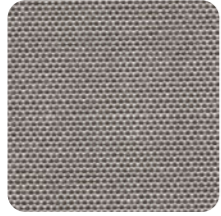

grigio Komodo .172
240 gr/m²

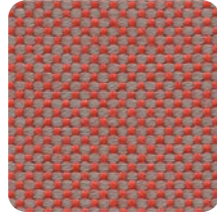

mattone .221
280 gr/m²

mass dyed acrylic fabric for Komodo Ombr



100% fibra acrilica tinto in massa. Trattamento idrorepellente, antimacchia, antimuffa. Solidità alla luce 7-8/8. Lavabile a 30°. Il tessuto Velo deve essere impiegato solo come telo-parasole. La maglia larga permette l'areazione e allo stesso tempo crea una zona d'ombra sottostante ma non trattiene l'acqua - 100% acrylic fiber mass dyed. Water repellent treatment, dirt repellent and anti-mould treatment. 7-8/8 light fastness. Washable at 30°. Velo fabric should only be used for sunshades. Its wide mesh allows ventilation while creating a shaded area below, but it does not retain water - 100% fibre acrylique teintée en masse. Traitement imperméable, anti-taches et anti-moisissure. Résistance à la lumière 7-8/8. Lavable à 30°. Le tissu Velo ne doit être utilisé que comme toile de parasol. Les mailles larges permettant de s'aérer tout en créant, en même temps, une zone d'ombre en dessous. Velo n'est pas imperméable - 100% fasergefärbtes Polyacryl. Wasserabweisend Ausrüstung, gegen Flecken und Schimmel ausgerüstet. Lichtechtheit 7-8/8. Waschbar bei 30°. Das Gewebe Velo darf nur als Sonnenschutz Tuch verwendet werden. Die großen Maschen gestatten die Belüftung und gleichzeitig bildet sich darunter ein Schattenbereich, doch es hält Wasser nicht

zurück - 100% fibra acrílica tintada en masa. Tratamiento hidropelente, protección antimanchas, antimoho. Solidez a la luz 7-8/8. Lavable a 30°. La tela Velo debe utilizarse únicamente como parasol, la malla ancha permite la ventilación y crea por debajo una zona de sombra, pero no protege del agua - 100% fibra acrílica tingida em massa. Tratamento hidropelente, antimancha e antimoho. Resistência à luz 7-8/8. Lavável a 30°. O tecido Velo deve ser utilizado apenas como pano guarda-sol, a malha larga permite o arejamento e ao mesmo tempo cria uma zona de sombra subjacente, mas não retém a água - %100 akrilik elyaf çözelti halindeyken boyanmış. Su itici, leke itici, küf önleyici ile muamele edilmiş. Işık haslıđı 7-8/8. 30°de yıkanabilir. Velo dokuma sadece güneşlik olarak kullanılmalıdır, geniş gözenekler havalandırma sağlar ve aynı zamanda aşağıda bir gölge alanı oluşturur, fakat su tutma özelliđi yoktur - 100% акриловое волокно, окрашенное в массе. Водоотталкивающая, пятноустойчивая и противоплесневая обработка. Светостойкость 7-8/8. стирать при 30°. Ткань Velo предназначена исключительно для использования в качестве тента для защиты от солнца. Переплетение в виде крупной сетки обеспечивает вентиляцию и в то же время создает затенение под собой, но не задерживает влагу.



velo white .203
150 gr/m²

TECH

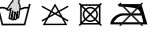

50% vinile e 50% poliestere. Trattamento idrorepellente, antimacchia, antimuffa, ignifugo e antibatterico. Solidità alla luce 6. Lavare a mano in acqua fredda. Alla base dei cuscini seduta comodo TECH panama viene applicata una rete a maglia larga in poliestere per permettere la traspirazione - 50% vinyl and 50% polyester. The treatment makes the coating: water repellent, and resistant to staining, resistant to mold, fire retardant, and antibacterial. 6 light fastness. Hand wash in cold water. At the bottom of the komodo seat cushions, made with TECH panama, the fabric is a polyester wide mesh to allow breathability - 50% vinyle et 50% polyester. Traitement hydrofuge, anti-taches, anti-moisissures, ignifugé et antibactérien. Résistance à la lumière 6. Laver à la main à l'eau froide. À la base des coussins d'assise comodo TECH panama, un filet de polyester à larges mailles est appliqué pour évacuer la transpiration - 50% Vinyl und 50% Polyester. Wasserabweisend, gegen Flecken und Schimmelbildung ausgerüstet, feuerfest und antibakteriell. Lichtechtheit 6. Handwäsche in kaltem Wasser. Auf der Unterseite der TECH panama Komodo-Sitzkissen ist ein atmungsaktives Polyesternetz mit großer Maschenweite angebracht,

um Luftaustausch zu ermöglichen - 50% vinilo y 50% poliéster. Tratamiento para repeler el agua, ignifugo y antibacteriano, protección antimanchas, antimoho. Solidez a la luz 6. Lavar a mano en agua fría. En la base de los cojines de asiento del komodo TECH panama, se aplica una red de poliéster de malla ancha para permitir la transpiración - 50% de vinil e 50% de poliéster. Tratamento hidropelente, antimancha e antimoho, resistente ao fogo e antibacteriano. Resistência à luz 6. Lavar à mão em água fria. Na base das almofadas do assento de comodo TECH panama, é aplicada uma tela de poliéster de malha larga para permitir a transpiração - % 50 vinil ve % 50 polyester. Su Geçirmez Uygulama,kir tutmaz ve küf önleyici uygulama,yangın geciktirici ve antibakteriyel uygulama. Işık haslıđı 6. Gerektiđinde, el ile sođuk suda yıkanabilir. Hava alması için komodo'nun altındaTECH panama minderle, geniş fileli polyester uygulanmıştır - 50% винил и 50% полиэстер. типы обработки: водоталкивающая,пятноталкивающая,пlesenьоталкивающая,невозгораемая и антибактериальная устойчивость к . Светостойкость 6. Ручная стирка в холодной воде. в основе подушек comodo материал Tech panama добавлена сетка с широкой вязкой из полиэстера, чтобы материал проветривался.



TECH panama .131
830 gr/m²

thermoformed Cuscino Trill

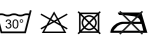

100% fibra acrilica tinto in massa. Trattamento idrorepellente, antimacchia, antimuffa. Solidità alla luce 7-8/8. Senza cuciture. Lavabile a 30°. Imbottitura: poliuretano espanso rivestito da una membrana TPU waterproof. Densità 40 kg/m³ - 100% acrylic fiber mass dyed. Water repellent treatment, dirt repellent and anti-mould treatment. 7-8/8 light fastness. Seamless. Washable at 30°. Padding: polyurethane foam with a TPU waterproof membrane coating. Density 40 kg/m³ - 100 % fibre acrylique teintée en masse. Traitement imperméable, anti-taches e anti-moisissure. Résistance à la lumière 7-8/8. Sans couture. Lavable à 30°. Rembourrage: mousse polyuréthane revêtu d'une membrane TPU imperméable. Densité 40 kg/m³ - 100 % fasergefärbtes Polyacryl. Wasserabweisend Ausrüstung, gegen Flecken und Schimmel ausgerüstet. Lichtechtheit 7-8/8. Ohne Nähte. Waschbar bei 30°. Polsterung: Polyurethanschaum mit einer wasserdichten TPU-Membran abgedeckt. Dichte

40 kg/m³ - 100% fibra acrílica tintada en masa. Tratamiento hidropelente, protección antimanchas, antimoho. Solidez a la luz 7-8/8. Sin costuras. Lavable a 30°. Relleno: espuma de poliuretano recubierto con una membrana de TPU impermeable. Densidad 40 kg/m³ - 100% fibra acrílica tingida em massa. Tratamento hidropelente, antimancha e antimoho. Resistência à luz 7-8/8. Sem costuras. Lavável a 30°. Enchimento: espuma de poliuretano com cobertura de membrana TPU impermeável. Densidade 40 kg/m³ - %100 akrilik elyaf çözelti halindeyken boyanmış. Su itici, leke itici, küf önleyici ile muamele edilmiş. Işık haslıđı 7-8/8.Dikişsiz. 30°de yıkanabilir. Dolgu malzemesi: TPU waterproof film ile kaplanmış poliüretan köpük. Yoğunluk 40 kg/m³ - 100% акриловое волокно окрашенное в массе. Водоотталкивающая, пятноустойчивая и противоплесневая обработка. Светостойкость 7-8/8. Без швов. Стирать при 30°. Набивка: пенополиуретан с покрытием из водостойкой мембраны ТПУ. Плотность 40 кг/м³.



grafite .130
500 gr/m²

100% Olefin fabric



100% Olefin tinto in massa. Trattamento antimacchia, antimuffa. Solidità alla luce 7/8. Lavabile a 40° - 100% Olefin mass dyed. Dirt repellent and anti-mould treatment. 7/8 light fastness. Washable at 40° - 100% Olefin teintée en masse. Traitement anti-taches et anti-moisissure. Résistance à la lumière 7/8. Lavable à 40° - 100% fasergefärbtes Olefin. Gegen Flecken und Schimmel Ausrüstung. Lichtechtheit 7/8. Waschbar bei 40° - 100% Olefin tintada

en masa. Proteccion antimanchas, antimoho. Solidez a la luz 7/8. Lavable a 40° - 100% Olefin tingida em massa. Tratamento antimancha e antimoho. Resistência à luz 7/8. Lavável a 40° - %100 Olefin çözültü halindeyken boyanmış. Leke itici, küf önleyici ile muamele edilmiş. Işık haslığı 7/8. 40°de yıkanabilir - 100% Olefin, окрашенный в массе. Пятноустойчивая и противоплесневая обработка. Светостойкость 7/8. Стирать при 40°.



bianco .155
190 gr/m²

telo mare Net Lounge

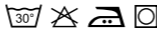

100% cotone. Trattamento IDH. Solidità alla luce 4/5. Lavabile a 30°, programma delicati - 100% cotton. IDH treatment. 4/5 light fastness. Washable at 30°C, delicates programme - 100 % coton. Traitement IDH. Résistance à la lumière 4/5. Lavable à 30°, programme délicat - 100 % Baumwolle. Ausrüstung: Indanthren. Lichtechtheit 4/5. Waschbar bei 30°, Schonprogramm - 100% algodón. Tratamiento IDH. Solidez a la luz 4/5. Lavable a

30°, programa delicado - 100% algodão. Tratamento IDH. Resistência à luz 4/5. Lavável a 30°, programa delicado - 100% pamuk. IDH işlemi. Işık haslığı 4/5. 30°de yıkanabilir, hassas program - 100%. Обработка изофтальевым дигидразидом (IDH). Светостойкость 4/5. Стирать при 30°, программа для деликатных тканей.

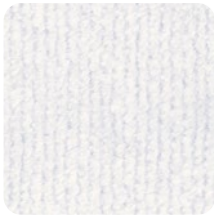

bianco .600
550 gr/m²



senape .656
550 gr/m²



corallo .675
550 gr/m²

padding

CUSCINO FOLIO COMFORT

Poliuretano espanso (densità 18 kg/m³) rivestito da fibra di poliesteri accoppiata al tessuto. Polyurethane foam (density 18 kg/m³) with a polyester fiber coating bonded to the fabric. Mousse polyuréthane (densité 18 kg/m³) revêtu de fibre de polyester couplé au tissu.Polyurethanschaum (Dichte 18 kg/m³) mit Polyesterfasern beschichtet, gekoppelt mit dem Gewebe. Espuma de poliuretano (densidad 18 kg/m³) cubierta con fibras de poliéster acoplada con el tejido. Espuma de poliuretano (densidade 18 kg/m³) com cobertura fibras de poliéster acoplada ao tecido. Kumaşa birleştirilmiş polyester elyafla kaplanmış genişletilmiş poliüretan (yoğunluk 18 kg/m³). Расширенный полиуретан (плотность 18 кг/м³), покрытый полиэфирным волокном, соединенным с тканью.

CUSCINO NET BENCH - CUSCINO NET RELAX - CUSCINO NET

Poliuretano espanso. Densità 28 kg/m³. Polyurethane foam. Density 28 kg/m³. Mousse polyuréthane. Densité 28 kg/m³. Polyurethanschaum. Dichte 28 kg/m³. Espuma de poliuretano. Densidad 28 kg/m³. Espuma de poliuretano. Densidade 28 kg/m³. Poliüretan köpük. Yoğunluk 28 kg/m³. Пенополиуретан. Плотность 28 кг/м³.

CUSCINO SHELL NET RELAX

Poliuretano espanso su struttura rigida di polipropilene. Densità 70 kg/m³. Polyurethane foam over solid polypropylene frame. Density 70 kg/m³. Mousse polyuréthane sur structure rigide de polypropylène. Densité 70 kg/m³. Polyurethanschaum auf steifer Polypropylengestell. Dichte 70 kg/m³. Espuma de poliuretano sobre estructura rígida de polipropileno. Densidad 70 kg/m³. Espuma de poliuretano sobre estrutura rígida de polipropileno. Densidade 70 kg/m³. Sert polipropilen gövde üzerinde poliüretan köpük minder. Yoğunluk 70 kg/m³. Пенополиуретан. на жесткой конструкции из полипропилена. Плотность 70 кг/м³.

CUSCINO BIT

Poliuretano espanso (densità 17,10 kg/m³) rivestito da fibra di poliesteri (densità 200 gr/m²). Polyurethane foam (density 17,10 kg/m³) with a polyester fiber coating (density 200 gr/m²). Mousse polyuréthane (densité 17,10 kg/m³) revêtu de fibre de polyester (densité 200 gr/m²). Polyurethanschaum (Dichte 17,10 kg/m³) mit Polyesterfasern beschichtet (Dichte 200 gr/m²). Espuma de poliuretano (densidad 17,10 kg/m³) cubierta con fibras de poliéster (densidad 200 gr/m²). Espuma de poliuretano (densidade 17,10 kg/m³) com cobertura fibras de poliéster (densidade 200 gr/m²). Polyester elyaf (Yoğunluk 200 gr/m²) kaplı köpük poliüretan (Yoğunluk 17,10 kg/m³). Пенополиуретан (Плотность 17,10 кг/м³) с покрытием из обшивки из полиэстера (Плотность 200 гр/м²).

CUSCINO DOGA RELAX - CUSCINO DOGA ARMCHAIR - CUSCINO DOGA BISTROT

Poliuretano espanso (densità 18 kg/m³) rivestito da fibra di poliesteri (densità 100 gr/m²). Polyurethane foam (density 18 kg/m³) with a polyester fiber coating (density 100 gr/m²). Mousse polyuréthane (densité 18 kg/m³) revêtu de fibre de polyester (densité 100 gr/m²). Polyurethanschaum (Dichte 18 kg/m³) mit Polyesterfasern beschichtet (Dichte 100 gr/m²). Espuma de poliuretano (densidad 18 kg/m³) cubierta con fibras de poliéster (densidad 100 gr/m²). Espuma de poliuretano (densidade 18 kg/m³) com cobertura fibras de poliéster (densidade 100 gr/m²). Polyester elyaf (Yoğunluk 100 gr/m²) kaplı köpük poliüretan (Yoğunluk 18 kg/m³). Пенополиуретан (Плотность 18 кг/м³) с покрытием из обшивки из полиэстера (Плотность 100 гр/м²).

CUSCINO SEDUTA MAXIMO

Poliuretano espanso (densità 25 kg/m²) rivestito da ovatta in fibra di poliesteri accoppiata a tessuto 100% poliesteri con trattamento Water Repellent (WR) (densità 400 gr/m²) e parte sottostante in rete di filato poliesteri (90 gr/m²). Polyurethane foam (density 25 kg/m²) covered with polyester fibre wadding coupled with 100% polyester fabric with Water Repellent (WR) treatment (density 400 g/m²) and polyester yarn mesh underneath (90 g/m²). Mousse polyuréthane (densité 25 kg/m²) recouvert d'une ouate de fibres de polyester couplée à un tissu 100% polyester avec traitement hydrofuge (WR) (densité 400 g/m²) et filet filé de polyester en dessous (90 g/m²). Polyurethanschaum (Dichte 25 kg/m²) mit mit Gewebe aus 100% Polyester mit Water-Repellent-Behandlung (WR) kaschierter Wattebeschichtung aus Polyesterfaser (Dichte 400 g/m²) und tragendem Netzgewebe aus Polyestergerarn (90 g/m²). Espuma de poliuretano (densidad 25 kg/m²) recubierta de guata de fibra de poliéster unida a tela 100% poliéster con tratamiento hidrorrepelente (WR) (densidad 400 g/m²) y parte inferior de malla de hilo de poliéster (90 g/m²). Espuma de poliuretano (densidade 25 kg/m²) revestido com ouate em fibra de poliéster

associada a tecido 100% poliéster com tratamento repelente a água (WR) (densidade 400 gr/m²) e parte inferior em rede de filamento de poliéster (90 gr/m²). Su geçirmezlik (WR) işlemine tabi tutulmuş, %100 polyester kumaş (yoğunluk 400 g/m²) ile birleştirilmiş polyester elyaf dolgu ile kaplanmış ve alt kısım polyester iplik ağında (90 g/m²) poliüretan köpük (yoğunluk 25 kg/m³). Пенополиуретан (плотность 25 кг/м³), покрытый ватой из полиэфирного волокна, сопряженной с тканью 100% полиэстер с водоотталкивающей пропиткой (Water Repellent - WR) (плотность 400 г/м²) и подложкой из сетки из полиэфирной пряжи (90 г/м²).

CUSCINO SCHIENALE MAXIMO CUSCINO SCHIENALE ANGOLO MAXIMO

Poliuretano espanso (densità 17 kg/m²) rivestito da ovatta in fibra di poliesteri accoppiata a tessuto 100% poliesteri con trattamento Water Repellent (WR) (densità 200 gr/m²). Polyurethane foam (density 17 kg/m²) covered with polyester fibre wadding coupled with 100% polyester fabric with Water Repellent (WR) treatment (density 200 gr/m²). Mousse polyuréthane (densité 17 kg/m²) recouvert d'une ouate de fibres de polyester couplée à un tissu 100% polyester avec traitement hydrofuge (WR) (densité 200 g/m²). Polyurethanschaum (Dichte 17 kg/m²) mit mit Gewebe aus 100% Polyester mit Water-Repellent-Behandlung (WR) kaschierter Wattebeschichtung aus Polyesterfaser (Dichte 200 g/m²). Espuma de poliuretano (densidad 17 kg/m²) recubierta de guata de fibra de poliéster unida a tela 100% poliéster con tratamiento hidrorrepelente (WR) (densidad 200 g/m²). Espuma de poliuretano (densidade 17 kg/m²) revestido com ouate em fibra de poliéster associada a tecido 100% poliéster com tratamento repelente a água (WR) (densidade 200 gr/m²). Su geçirmezlik (WR) işlemine tabi tutulmuş, %100 polyester kumaş (yoğunluk 200 g/m²) ile birleştirilmiş polyester elyaf dolgu ile kaplanmış poliüretan köpük (yoğunluk 17 kg/m³). Пенополиуретан (плотность 17 кг/м³), покрытый ватой из полиэфирного волокна, сопряженной с тканью 100% полиэстер с водоотталкивающей пропиткой (Water Repellent - WR) (плотность 200 г/м²).

CUSCINO SEDUTA KOMODO

Poliuretano espanso (densità 29 kg/m³) rivestito da fibra di poliesteri (densità 450 gr/m²). Polyurethane foam (density 29 kg/m³) with a polyester fiber coating (density 450 gr/m²). Mousse polyuréthane (densité 29 kg/m³) revêtu de fibre de polyester (densité 450 gr/m²). Polyurethanschaum (Dichte 29 kg/m³) mit Polyesterfasern beschichtet (Dichte 450 gr/mm²). Espuma de poliuretano (densidad 29 kg/m³) cubierta con fibras de poliéster (densidad 450 gr/m²). Espuma de poliuretano (densidade 29 kg/m³) com cobertura fibras de poliéster (densidade 450 gr/m²). Polyester elyaf (Yoğunluk 450 gr/m²) kaplı köpük poliüretan (Yoğunluk 29 kg/m³). Пенополиуретан (Плотность 29 кг/м³) с покрытием из обшивки из полиэстера (Плотность 450 гр/м²).

CUSCINO SCHIENALE KOMODO CUSCINO SCHIENALE ANGOLO KOMODO

Poliuretano espanso (densità 18 kg/m³) rivestito da fibra di poliesteri (densità 450 gr/m²). Polyurethane foam (density 18 kg/m³) with a polyester fiber coating (density 450 gr/m²). Mousse polyuréthane (densité 18 kg/m³) revêtu de fibre de polyester (densité 450 gr/m²). Polyurethanschaum (Dichte 18 kg/m³) mit Polyesterfasern beschichtet (Dichte 450 gr/m²). Espuma de poliuretano (densidad 18 kg/m³) cubierta con fibras de poliéster (densidad 450 gr/m²). Espuma de poliuretano (densidade 18 kg/m³) com cobertura fibras de poliéster (densidade 450 gr/m²). Polyester elyaf (Yoğunluk 450 gr/m²) kaplı köpük poliüretan (Yoğunluk 18 kg/m³). Пенополиуретан (Плотность 18 кг/м³) с покрытием из обшивки из полиэстера (Плотность 450 гр/м²).

CUSCINO POGGIATESTA FOLIO CUSCINO POGGIATESTA NET LOUNGE

Fibra di Poliesteri rivestito da poliesteri water repellent - Polyester fiber coated with water repellent polyester - Fibre de polyester enduite de polyester hydrofuge - Mit wasserabweisendem Polyester beschichtete Polyesterfaser - Fibra de poliéster recubierta de poliéster hidrorrepelente - Fibra de poliéster revestido de poliéster resistente à água - Su geçirmez kaplamalı polyester elyaf - Полиэфирное волокно с водоотталкивающим полиэфирным покрытием.

CUSCINO PASSEPARTOUT - CUSCINO RETTANGOLARE - CUSCINO ARREDO MAXIMO

Fibra di poliesteri. Polyester fiber. Fibre de polyester. Polyesterfaser. Fibras de poliéster. Fibras de poliéster. Polyester elyaf. Обшивка из полиэстера.

synthetic fabric

Tessuto in filo di poliestere rivestito in pvc - Fabric is made of a polyester fiber, with a pvc coating - Tissu en fil de polyester revêtu de pvc - Gewebe aus PVC-ummantelten Polyesterfasern - Tejido en hilo de poliéster recubierto

de pvc - Tecido de fibra polyester com cobertura pvc - PVC kaplı polyester elyaf tekstil - Ткань из полиэфирных нитей с покрытием из ПВХ.

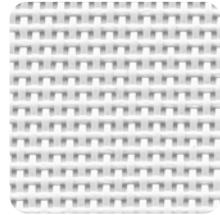

bianco .107
tela 1x1

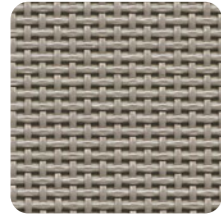

tortora .104
tela 1x1

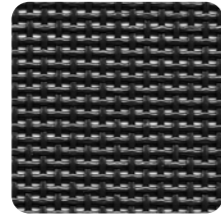

antracite .057
tela 1x1

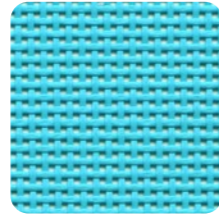

celeste .075
tela 1x1

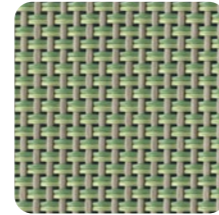

agave .101
tela 2x1

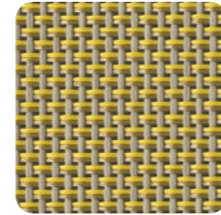

deserto .103
tela 2x1

Cover fabric

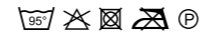

56% poliestere e 44% poliuretano. Trattamento idrorepellente, antimacchia, antimuffa e antibatterico. Solidità alla luce 7/8. Lavabile a 95° con detergente neutro - 56% polyester and 44% polyurethane. The treatment makes the coating: water repellent, and resistant to staining, resistant to mold and antibacterial. 7/8 light fastness. Washable at 95° with neutral detergent - 56% polyester et 44% polyuréthane. Traitement imperméable, anti-taches, anti-moisissures et antibactérien. Résistance à la lumière 7/8. Lavable à 95° avec un détergent neutre - 56% Polyester und 44% Polyurethan. Wasserabweisend, gegen Flecken und Schimmelbildung ausgerüstet und antibakteriell. Lichtechtheit 7/8. Waschbar bei 95° mit Neutralwaschmittel - 56%

poliéster y 44% poliuretano. Tratamiento para repeler el agua, antimanchas, antimoho y antibacteriano. Solidez a la luz 7/8. Lavable a 95° con detergente neutro - 56% de poliéster e 44% poliuretano. Tratamiento hidrorrepelente, antimancha, antimoho e antibacteriano. Resistência à luz 7/8. Lavável a 95° com detergente neutro - % 56 polyester ve % 44 poliüretan. Su Geçirmez Uygulama,kir tutmaz ve küf önleyici uygulama, antibakteriyel uygulama. Işık haslığı 7/8. Naturel deterjanla 95°de yıkanabilir - 56% полиэстер и 44% полиуретан. типы обработки: водоталкивающая,пятноталкивающая,плесеньоталкивающая, и антибактериальная устойчивость к. Светостойкость 7/8. Можно стирать при 95 ° с нейтральным моющим средством.



smoke .204
205 gr/m²

coated aluminium

La verniciatura è a polvere di poliestere - The painting is with polyester powder - La peinture est à poudre de polyester - Die Epoxierung erfolgt mit Polyesterpulver - El pintado se realiza con polvo de poliéster - O pó de

poliéster è usado para envernizar - Boyası polyester tozla yapılır - Окраска производится при помощи порошкового полиэстера.



verniciato bianco .53



verniciato antracite .52



verniciato corda .69



verniciato tortora .59



verniciato tabacco .67



verniciato terra .68

glass

Vetro extrachiario temperato. Spessore 6 mm - Extra-clear tempered glass. Thickness 6 mm - Verre trempé extra clair. Epaisseur 6 mm - Extra klares gehärtetes Glas. Dicke 6 mm - Vidrio templado extra claro. Espesor 6 mm

- Vidro temperado extra claro. Espessura 6 mm - Ekstra net temperli cam. Kalınlık 6 mm - Особо прозрачное закаленное стекло. Толщина 6 мм.

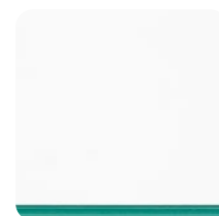

vetro .501

durelTOP



DurelTOP è un sistema innovativo di produzione di piani per tavoli studiati per raggiungere i più elevati livelli di praticità, resistenza, robustezza ed eleganza. I piani DurelTOP sono ad alto spessore, formati da un doppio strato tamburato perfettamente chiuso. Prodotti in polipropilene di prima qualità, sono inalterabili all'acqua, resistenti al sole e facili da pulire. DurelTOP è il risultato di una lunga ricerca tecnologica e dell'esperienza decennale nella lavorazione delle materie plastiche della NARDI, da sempre all'avanguardia nell'ambiente contract e giardino.

The DurelTOP is an innovative new system in the production of tabletops developed to reach the highest levels of practicality, resistance, and elegance. The DurelTOP tabletops have a greater thickness, formed by a double layer enclosure perfectly closed. Produced in first quality polypropylene, they are resistant to water, resistant to sunlight, and are easy to clean. DurelTOP is a result of a decade's long research and development in plastics by NARDI, always a leader in the contract and garden sectors.

DurelTOP est un système innovateur de production de plateaux de tables, il est étudié pour retrouver le meilleur niveau de pratique de résistance et d'élégance. Les plateaux DurelTOP sont très épais, formés de doubles couches parfaitement finies. Ce sont des produits en polypropylène de première qualité, ils sont inaltérables à l'eau, résistant au soleil et faciles à nettoyer. DurelTOP est le résultat d'une longue recherche technologique et une expérience décennale dans le travail des matières plastique de la Sté NARDI, toujours a l'avant-garde dans le secteur du contract et jardin.

DurelTOP ist ein neu entwickeltes System für die Produktion von Tischplatten, um ein Höchstmaß an Funktionalität, Widerstandsfähigkeit und Eleganz zu erreichen. Durch das innen verstärkte "Zwei-Schichten-Hohlraum-System" erreicht die DurelTOP Tischplatte einen stärkeren Querschnitt und damit ein Höchstmaß an Festigkeit. Hergestellt aus hochwertigem Qualitätspolypropylen ist sie resistent gegen Wasser und Sonnenlicht und dabei leicht zu reinigen. DurelTOP ist das Ergebnis von 10 Jahren Forschung und Entwicklung auf dem Kunststoffsek-

tor durch NARDI, immer der führende im Bereich Contract- und Gartenmöbel. DurelTOP es un nuevo sistema de fabricación de tableros de mesa estudiado para alcanzar los mas altos niveles de practicidad, resistencia, robustez y elegancia. Los tableros DurelTOP de gran solidez, estan formados por una doble capa perfectamente unida y sellada. Fabricados en polipropileno de primera calidad son inalterables al agua, resistentes al sol y de fácil limpieza. DurelTOP es el resultado de una prolongada investigación tecnológica y de la experiencia acumulada en los mas de diez años que NARDI lleva produciendo materias plasticas, siempre innovando en ambientes contract y jardin.

DurelTOP é um sistema de inovação da produção de tampos de mesa concebidos para atingir a máxima resistência,práticos e elegantes. Os tampos de mesa DurelTOP são formados poruma camada dupla e perfeitamente unida. Produzidos em polipropileno de primeira qualidade, são resistentes ao sol e fáceis de limpar. DurelTOP é o resultado de uma longa investigação tecnológica em materiais plásticos da NARDI, leader em mobiliário de jardim.

DurelTOP, masa tablalarının üretiminde kullanılan yeni bir sistem olup, yüksek seviyede pratiklik, direnç ve de ışıklık sunmak amacıyla geliştirilmiştir. DurelTOP masa tablaları fevkalade bir inceliğe sahip olup, kusursuz kapanan çift tabaka çevirme sistemiyle oluşturulmuştur. Nitelikli çamsakızından üretilmiş olup, suya ve güneş ışığına karşı dirençli ve temizlenmesi kolaydır. DurelTOP sistemini Contract ve de Bahçe sektöründe her zaman lider olan NARDI'nin uzun araştırmalarının sonucundan doğan, plastikte gelişim olarak adlandırabiliriz.

DurelTOP — это инновационная система производства столешниц, позволяющая изготавливать практичные, прочные, крепкие и элегантные столешницы. Столешницы DurelTOP обладают высокой плотностью и состоят из двойной панели с мелкопустотным заполнением, полностью закрытой. Изделия из полипропилен высокого качества устойчивы к воде, солнцу и просты в уходе. DurelTOP — это результат многолетних технологических исследований и десятилетнего опыта NARDI в обработке пластмасс, лидера в производстве садовой мебели и контрактном секторе.

 impilabile - stackable - empilable - stapelbar - apilable - empilhável - istiflenebilir - стекируемые

 impilabile orizzontalmente - stackable horizontally - piètement encastrable - Ineinander stapelbar - apilable horizontalmente - empilhável horizontalmente - yatay olarak istiflenebilir - горизонтальная расстановка

 pieghevole - folding - pliant - klappbar - plegable - dobrável - katlanabilir - складывающийся

 reclinabile - reclining - dossier réglable - verstellbare Rückenlehne - reclinable - reclinável - sırt pozisyonlu - откидной

Tutte le sedute sono dotate di piedini antiscivolo - All chairs are equipped with non-slip feet - Tous les sièges sont équipés avec patins anti-dérapants - Alle Stühle sind mit rutschfesten Fußkappen ausgestattet - Todos los asientos están equipados con tapones antideslizantes - Todos os assentos estão equipados com pés antiderrapantes - Bütün sandalyeler kaymaz ayaklıdırlar -Ножки всех стульев оснащены противоскользящей резиновой подложкой

Sui colori scuri, ombre, striature ed altri difetti minori sono più evidenti rispetto ai colori chiari e sono da ritenersi standard. On dark colors, shadows, streaks and other minor faults are more evident than on lighter colors and are therefore standard. Sur les couleurs sombres, les ombres, les stries et les autres petits défauts sont plus marqués que sur les couleurs claires et sont tout à fait standards. Auf dunklen Farben sind Schatten, Streifen und andere kleinere Mängel sichtbarer als auf hellen Farben und sind daher als Standard zu betrachten. Las sombras, rayas y demás defectos menores son más evidentes sobre los colores oscuros respecto a los colores claros y tienen que considerarse como estándares. Em cores escuras, sombras, listras e outros defeitos menores são mais evidentes do que em cores claras e devem ser considerados standard. Koyu renkler üzerinde, gölgeler, çizgiler ve diğer küçük defolar açık renkler üzerinde olduklarından daha belirginleşmekte ve bu nedenle normal olarak değerlendirilmelidirler. По сравнению со светлыми цветами на темных цветах тени полоска и другие небольшие дефекты более заметны и должны считаться нормой.

Il peso (kg), le misure (cm) e i colori riportati sono indicativi. Le dimensioni riportate di tutti i prodotti hanno una tolleranza di + o - 5 mm. NARDI si riserva il diritto di apportare modifiche o varianti senza preavviso. Tutti i modelli sono depositati. Weights (kg), dimensions (cm) and colors are indicative only. The dimensions given for all products have a tolerance of + or - 5 mm. NARDI reserves the right to make changes or variations without notice. All models are patented. Le poids (kg), les dimensions (cm) et les coloris indiqués sont fournis purement à titre indicatif. Les dimensions indiquées de tous les produits ont une tolérance de + ou - 5 mm. NARDI se réserve le droit d'apporter toute modification ou variation sans aucun préavis. Tous les modèles sont déposés. Alle Farb-, Maß-, (cm) und Gewichtsangaben (kg) sind nicht als fest bindend anzusehen. Die angegebenen Maße aller Produkte unterliegen einer Toleranz von + oder - 5 mm. NARDI behält sich das Recht von Anderungen. Alle Modelle sind gesetzlich geschützt. El peso (kg), las medidas (cm) y los colores detallados, son indicativos. Las dimensiones indicadas de todos los productos tienen una tolerancia de + o - 5 mm. NARDI se reserva el derecho de modificaciones o variaciones sin previo aviso. Todos los modelos llevan nuestra marca. O peso (kg), as medidas (cm) e as cores indicadas, são indicativos. As dimensões mostradas de todos os produtos têm uma tolerância de + ou - 5 mm. NARDI reservase o direito de aportar modificações ou variações sem préaviso. Todos os modelos estão depositados. Ağırlık (Kg), boyutlar (cm) ve renkler gösterme amaçlıdır. Tüm ürünler için verilen .l.üler + ya da - 5 mm toleransa sahiptir. (3 5 mm) NARDI'nin önceden bildirmeden değişiklik yapma hakkı vardır. Bütün modeller patentlidir. Приведенный вес (кг), размеры (см) и цвета являются ориентировочными. Размеры всех изделий приводятся с допуском + / - 5 mm. Компания NARDI оставляет за собой права вносить изменения и вариации без предварительного предупреждения. Все модели зарегистрированы.

STYLING
Vanessa Pisk
Elisa Musso
Studio Salaris
Cristina Nava
Elena Mora

THANKS TO
Aytm
Bitossi Home
Bloomingville
Ichendorf
Incipit Lab
L'Abitare
Normann Copenhagen
Karpeta
Flos Outdoor

GRAPHIC DESIGN PHOTO
Studio Raffaello Galiotto



1010112025

NARDI s.p.a.
Chiampo (VI) Italy
tel. +39 0444 422100
info@nardioutdoor.com
www.nardioutdoor.com

